

FRASCOLD®



CXH

FRASCOLD
75
YEARS
1936 - 2011



Semi-hermetic compact screw compressors
Compressori semiermetici compatti a vite
Halbhermetische Kompakt-Schraubenverdichter

FCAT200.2
Product Selection Catalogue
Version 50 Hz - 60 Hz



FRASCOLD

75
YEARS

1936 - 2011

Frascold compie 75 anni dalla fondazione e guarda al futuro.

Dal 1936 a oggi, un lungo cammino fatto di trasformazioni e attenzione alle tecnologie più avanzate.

In tutto questo tempo Frascold ha prodotto compressori a servizio dell'industria della refrigerazione e del condizionamento dell'aria commercializzandoli in tutto il mondo per una grande varietà di applicazioni.

Ha costruito la propria reputazione e affermazione sul mercato internazionale grazie alla elevata capacità di migliorare costantemente il prodotto e le tecnologie, valorizzando nello stesso tempo le relazioni con i clienti in maniera da mantenersi alla testa del proprio settore.

Frascold è una realtà industriale che opera a livello mondiale con esperienza, risorse, tecnologie e grande capacità delle persone. Frascold ha gli strumenti per dare vicinanza a rapide risposte alle necessità del mercato e guarda fiduciosa al proprio futuro.

Con la nostra tecnologia, l'esperienza applicativa e la presenza globale, offriamo prodotti, soluzioni e servizi che consentono ai nostri clienti di ottenere vantaggi in termini di prestazioni, efficienza energetica e confort di funzionamento.

I nostri compressori sono utilizzati nei molteplici settori della refrigerazione, condizionamento dell'aria, pompe di calore, e influenzano la vita quotidiana di molte persone.

Frascold was founded 75 years ago and is looking to the future.

Its long journey from 1936 to the present day has been marked by transformations and attention to cutting-edge technology.

From its founding, Frascold has produced compressors for the refrigeration and air conditioning industry, selling them all over the world for a broad range of applications.

It has built its international reputation and recognition on its outstanding capacity to improve its products and technologies, at the same time valuing customer relations so as to stay at the top of the industry.

Frascold is a manufacturing company that operates world-wide, bringing experience, resources, technology and highly-skilled personnel to all of its activity. Frascold has the tools to provide proximity and act quickly in response to market needs, and is looking confidently to its future.

With our technology, application experience and global presence, we offer products, solutions and services that provide our customers with advantages in terms of performance, energy efficiency and operational comfort.

Our compressors are used in numerous refrigeration, air conditioning and heat pump sectors, affecting the daily life of countless people.

Frascold feiert seinen 75. Geburtstag seit der Gründung und schaut in die Zukunft.

Seit 1936 bis heute, ein langer Weg voller Veränderungen und immer mit dem Augenmerk auf die modernsten Technologien.

In dieser Zeit hat Frascold Verdichter für die Kälte- und Klimaindustrie produziert und für verschiedenste Anwendungen in die ganze Welt vertrieben.

Wir haben unseren Ruf und Erfolg auf dem internationalen Markt unserer ausgeprägten Fähigkeit zu verdanken, unsere Produkte und Technologien beständig zu verbessern. Außerdem messen wir der Beziehung zu unseren Kunden eine hohe Bedeutung zu – nur so können wir uns an der Spitze der Branche halten.

Frascold ist ein Industrieunternehmen, das weltweit mit Erfahrung, Ressourcen, Technologien und der umfassenden Kompetenz seiner Mitarbeiter tätig ist. Frascold verfügt über sämtliche Instrumente, um zeitnah auf die Marktanforderungen reagieren zu können, und blickt daher zuversichtlich in die Zukunft.

Mit unserer Technologie, Anwendungserfahrung und globaler Präsenz bieten wir Produkte, Lösungen und Dienstleistungen, die unseren Kunden zu Vorteilen hinsichtlich Leistungen, Energieeffizienz und Betriebskomfort verhelfen.

Unsere Verdichter werden in zahlreichen Branchen wie der Kälte- und Klimaindustrie sowie für Wärmepumpen eingesetzt, sie und beeinflussen das tägliche Leben vieler Menschen.

Compressori semiermetici compatti a vite serie CXH

Semi-hermetic compact screw compressors CXH

Halbhermetische kompakt-Schraubenverdichter CXH

I compressori della serie CXH sono stati sviluppati per applicazioni universali in sistemi di refrigerazione, condizionamento dell'aria, pompe di calore.

Generalità

I compressori della serie CXH sono progettati per funzionare in modo affidabile e con minimi interventi di manutenzione, implementano soluzioni tecniche dedicate alla riduzione della rumorosità e hanno coefficienti di rendimento molto elevati anche a carichi parziali.

Sono disponibili in 27 diversi modelli con spostamenti volumetrici da 199 a 912 m³/h.

Coprono una richiesta frigorifera fino a 1600 kW.

Caratteristiche tecniche distinte

- i motori elettrici sono del tipo ad elevato rendimento con avviamento frazionato (PWS) per i modelli CXH0... e CXH5... o a stella/triangolo (SDS) sui modelli CXH9... La protezione termica è garantita da sensori PTC integrati in ciascun avvolgimento
- il motore di normale fornitura può essere pilotato da un inverter di potenza adeguata in un campo di frequenze compreso tra i 30 e i 70 Hz: per questo utilizzo si prega di contattare il nostro Servizio Tecnico
- il sofisticato sistema di controllo della capacità, a gradini o in continuo, permette di ottenere elevati valori di rendimento sia a pieno carico che a carico parzializzato e garantisce il preciso funzionamento della regolazione in continuo anche in condizioni di impiego critiche, oltre ad offrire un sistema integrato di partenza a vuoto
- il separatore d'olio a tre stadi ad elevatissima efficienza minimizza la quantità di olio che circola nel sistema di refrigerazione
- il sistema di gestione dell'olio include un filtro a cartuccia, facilmente accessibile e sostituibile, che può essere dotato di un sensore di intasamento e può essere ulteriormente completato con un flussostato e con un sensore di livello
- l'innovativa configurazione dei cuscinetti protegge le viti da eventuali controrotazioni che si potrebbero verificare in fase di arresto del sistema. Per questa serie di compressori sono stati progettati dei cuscinetti speciali con una gabbia che contribuisce a ridurre la rumorosità e ad aumentare il loro coefficiente di carico e la loro vita operativa
- la specifica costruzione a doppia parete del corpo rotorotori ed il disegno del profilo delle viti contribuiscono a rendere questi compressori molto più silenziosi degli equivalenti modelli presenti sul mercato, con dimensioni ed ingombri tra i più compatti in assoluto

Equipaggiamento standard e accessori offerti in opzione

L'equipaggiamento fornito è tra i più completi:

- valvola di scarico e flangia di aspirazione con boccola a saldare
- controllo di capacità / avviamento a vuoto
- valvola di non ritorno sulla mandata
- riscaldatore olio termostato
- doppia spia livello olio (minimo e massimo)
- valvola di servizio dell'olio
- filtro olio a cartuccia facilmente accessibile e sostituibile
- filtro di aspirazione
- sonda PTC di massima temperatura dell'olio
- modulo di protezione elettronico T00EC45A (ripristino manuale).

Oltre a monitorare la temperatura del motore elettrico e controllare il corretto funzionamento della catena dei termistori, il modulo verifica la presenza delle

The CXH series compressors were developed for universal applications in refrigeration, air conditioning and heat pump systems.

General details

CXH series compressors are designed to operate reliably and with minimal required maintenance; they implement technical solutions dedicated to noise reduction and have high coefficients of performance even with partial loads.

They are available in 27 different models with volume displacements from 199 to 912 m³/h.

They cover refrigerant requirements up to 1600kW.

Main Features

- high efficiency electric motors with part winding start (PWS) on CXH0... and CXH5... models or star-delta-start (SDS) on CXH9... models. Thermal protection is guaranteed by PTC sensors integrated in each winding
- a sophisticated step or stepless capacity control system delivers very high efficiency values, both at full and partial load, and guarantees precise stepless capacity regulation even in critical operating conditions, in addition to enabling start unloading
- the very high efficiency three stages integrated oil separator minimises the quantity of lubricant that circulates in the refrigeration system
- the oil management system includes an easily accessible and replaceable cartridge type oil filter that can be equipped with an optional differential oil pressure switch to monitor filter clogging and can be further completed by an optional oil flow switch and an optional oil level sensor
- the innovative configuration of the bearings protects the screw pairs from possible counter-rotations that might originate during system stops. The bearings of this series have been newly designed to incorporate a special cage which contributes to reduce their noise levels and increase their load rating and life
- the standard electric motor supplied with the compressors can be driven by an inverter of suitable power in a range of frequencies between 30 and 70 Hz: for this application please consult our Technical Service
- the specific double walled compressor rotor body construction and the design of the screw profiles contribute to reduce the noise of these compressors to a level lower than the equivalent models available on the market, offering some of the most compact sizes and dimensions

Standard equipment and optional

The standard extent of delivery is one of the most complete available on the market:

- discharge valve and suction flange connection with solder sleeve
- capacity control / unloaded start
- check valve on the discharge port
- oil heater with temperature control
- double oil sight glass (minimum and maximum levels)
- oil service valve
- easily accessible and replaceable oil filter (cartridge type)
- suction filter
- oil temperature PTC sensor
- electronic protection module T00EC45A (manual reset).

On top of monitoring the motor windings

Die Kompressoren der Serie CXH wurden für allgemeine Anwendungen in Kühlsystemen, Klimaanlage und Wärmepumpen konzipiert.

Allgemeines

Die Kompressoren der Serie CXH überzeugen durch ihren zuverlässigen, wartungsarmen Betrieb, weisen besondere Techniken zur Reduzierung der Schallemissionen auf und haben selbst bei partiellen Lasten äußerst hohe Leistungskoeffizienten.

Die Produktserie umfasst 27 verschiedene Modelle im Volumenbereich von 199 bis 912 m³/h.

Sie sind für Kühlleistungen bis 1600 kW geeignet.

Technische Merkmale der Anlage

- Bei diesen Elektromotoren handelt es sich um Hochleistungsmotoren mit Teilwicklungsstart (PWS) für die Modelle CXH0... und CXH5... oder um Stern-Dreieck-Motoren (SDS) bei den Modellen CXH9... Der Thermoschutz wird durch PTC-Sensoren gewährleistet, die in jeder Wicklung integriert sind
- Der standardmäßig ausgelieferte Motor kann mit einem geeigneten Inverter in einem Frequenzbereich zwischen 30 und 70 Hz gesteuert werden: Wenden Sie sich für diese Art der Anwendung bitte an unseren technischen Kundendienst
- Das hoch entwickelte stufenlose Leistungsregelungssystem ermöglicht es, sowohl bei Vollast als auch bei Teillast hohe Leistungswerte zu erzielen. Ferner garantiert dieses System die präzise Funktionsweise der stufenlosen Regulierung auch unter kritischen Betriebsbedingungen. Außerdem bietet es ein integriertes System der Anlaufentlastung
- Der dreistufige Ölabscheider mit hohem Wirkungsgrad, minimiert die Ölmenge, die durch den Kältekreislauf fließt
- Das Öl-Management-System umfasst einen Kartuschenfilter, der leicht zugänglich und austauschbar ist. Dieser kann mit einem Verschmutzungssensor ausgestattet und zusätzlich mit einem Durchflusswächter und einem Füllstandsensor ergänzt werden
- Die innovative Konfiguration der Lager schützt die Schrauben bei möglicher Rückwärtsdrehung, die bei Anhalten des Systems auftreten können. Für diese Serie von Verdichtern wurden Speziallager mit einem Käfig entwickelt, der zur Lärmreduzierung beiträgt und den Belastungskoeffizienten sowie die Betriebslebensdauer der Lager erhöht
- Die besondere doppelwandige Konstruktion des Rotorenhäuses und das Profildesign der Schrauben tragen dazu bei, dass diese Verdichter sehr viel leiser als vergleichbare auf dem Markt erhältliche Modelle sind und dank ihrer Größe und Abmessungen zu den absolut kompaktesten Geräten zählen

Standardausrüstung und Zubehör

Die Standardausrüstung gehört zu den umfassendsten:

- Auslassventil und Ansaugflansch mit Anschweißbuchse
- Leistungskontrolle / Anlaufentlastung
- Druckseitiges Absperrventil
- Elektrische Ölheizung mit Temperaturkontrolle
- Doppelte Ölstandanzeige (Minimum und Maximum)
- Ölserviceventil
- Leicht zugänglicher und austauschbarer Öl-Kartuschenfilter
- Ansaugfilter
- PTC-Fühler für Öltemperaturüberwachung

fasi e il senso di rotazione all'avviamento e controlla la temperatura dell'olio tramite la sonda PTC dedicata

- option:
 - valvola di aspirazione
 - valvola per economizzatore con smorzatore di pulsazioni
 - sensore di livello olio optoelettronico (il prisma in vetro del sensore viene premontato sul corpo del compressore per evitare eventuali inutili operazioni di scarico e carico del lubrificante)
 - flussostato olio
 - sensore di intasamento filtro olio
 - modulo elettronico di gestione allarmi
 - barrette di collegamento per avviamento DOL
 - kit supporti antivibranti in gomma

temperature and controlling the correct operation of the thermistor chain, the module checks the presence of phases and the correct rotation direction at start and controls the oil temperature through the dedicated PTC sensor

- option:
 - suction valve
 - economiser connection valve with pulsation damper
 - optoelectronic oil level switch (the glass dome is pre-assembled on the compressor body to avoid unnecessary drainage and charge of lubricant)
 - oil flow switch
 - differential oil pressure switch (filter clogging)
 - electronic alarm management control module
 - bridges for DOL start
 - rubber vibration absorber kit

• Elektronisches Motorschutzgerät T00EC45A (manuelle Rückstellung).

Das Modul überwacht nicht nur die Temperatur des Elektromotors und die korrekte Funktionsweise der Thermistorenkette, sondern prüft auch die Anwesenheit der Phasen und die Drehrichtung beim Anlauf.

Außerdem kontrolliert es über die dazu vorgesehene PTC-Sonde die Öltemperatur

- Option
 - Ansaugventil
 - Economizer-Ventil mit Pulsationsdämpfer
 - Optoelektronischer Ölstandsensor (das Glasprisma des Sensors wird am Körper des Verdichters vormontiert, um eventuelle unnötige Befüllungs- und Ablassarbeiten des Schmiermittels zu vermeiden)
 - Öl-Durchflusswächter
 - Ölfilter Verschmutzungssensor
 - Elektronisches Modul für die Alarmsteuerung
 - Schaltbrücken für DOL-Anschluss
 - Schwingungsdämpfersatz aus Gummi

Nomenclatura modello Model designation Modellbezeichnung

CXH51-140-538Y

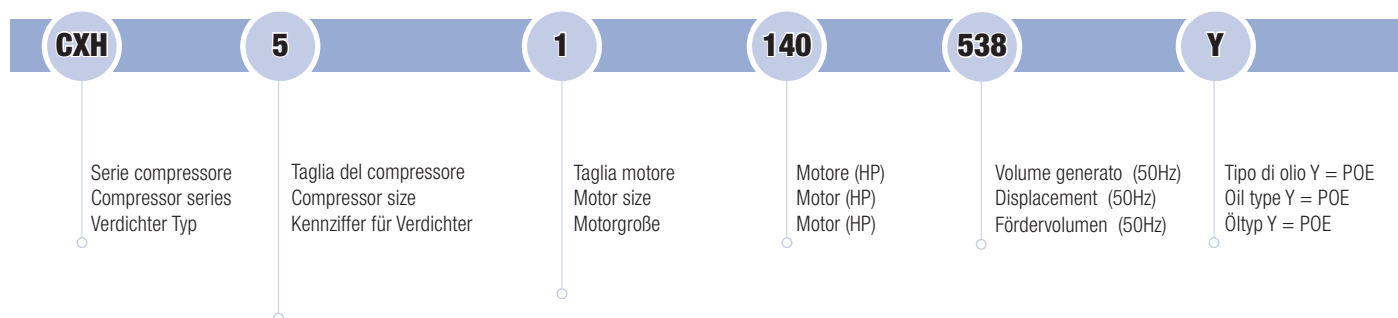

Dati tecnici compressori
Compressors technical data
Technischen Daten

Compressore Compressor Verdichter	Taglia motore - Motor size - Motorgroße	Motore Motor Motor	Volume generato 50 Hz /60 Hz	Carica di olio	Peso netto	Raccordi linea				Massima corrente operativa	Massima potenza assorbita	Corrente di avviamento
			Displacement 50 Hz /60 Hz	Oil charge	Net weight	Pipe connections				Maximum operating current	Maximum input power	Locked rotor current
			Fördervolumen 50 Hz /60 Hz	Ölfüllung	Netto- gewicht	Rohranschlüsse				Max Betriebsstrom	Max Leistungsaufnahme	Anlaufstrom
			Ø mm	Ø"	Ø mm	Ø"	A	kW	Δ / ΔΔ			
①	②	③	④	⑤	Mandata Discharge Saugleistung	Aspirazione Suction Druckleistung	⑥	⑥	⑦			
CXH01-50-199Y	1		199 / 239	18	490	54,0	2 1/8"	79,4	3 1/8"	80	57,06	203 / 330
CXH02-70-199Y	2		199 / 239	18	510	54,0	2 1/8"	79,4	3 1/8"	128	100,20	298 / 518
CXH01-60-230Y	1	⑥ ⑦	230 / 276	18	505	54,0	2 1/8"	79,4	3 1/8"	98	73,80	262 / 425
CXH02-80-230Y	2		230 / 276	18	520	54,0	2 1/8"	79,4	3 1/8"	145	113,64	373 / 600
CXH01-70-264Y	1		264 / 317	18	505	54,0	2 1/8"	79,4	3 1/8"	125	81,24	298 / 518
CXH02-90-264Y	2		264 / 317	18	520	54,0	2 1/8"	79,4	3 1/8"	160	123,96	405 / 649
CXH01-80-298Y	1		298 / 358	18	515	54,0	2 1/8"	79,4	3 1/8"	145	96,36	373 / 600
CXH02-100-298Y	2		298 / 358	18	525	54,0	2 1/8"	79,4	3 1/8"	175	138,24	488 / 767
CXH01-90-340Y	1		340 / 408	18	525	54,0	2 1/8"	79,4	3 1/8"	160	103,20	405 / 649
CXH02-120-340Y	2		340 / 408	18	537	54,0	2 1/8"	79,4	3 1/8"	195	152,28	505 / 793
CXH01-100-370Y	1		370 / 444	18	540	54,0	2 1/8"	79,4	3 1/8"	145	112,32	488 / 767
CXH52-110-316Y	2		316 / 379	22	865	79,4	3 1/8"	104,0	4 1/8"	184	141,48	434 / 720
CXH52-125-372Y	2		372 / 446	22	865	79,4	3 1/8"	104,0	4 1/8"	218	168,12	530 / 838
CXH51-110-398Y	1		398 / 478	22	870	79,4	3 1/8"	104,0	4 1/8"	180	119,64	434 / 720
CXH52-140-428Y	2		428 / 514	22	875	79,4	3 1/8"	104,0	4 1/8"	245	188,28	587 / 921
CXH51-125-468Y	1		468 / 562	22	875	79,4	3 1/8"	104,0	4 1/8"	198	139,32	530 / 838
CXH52-160-468Y	2		468 / 562	22	878	79,4	3 1/8"	104,0	4 1/8"	282	213,60	729 / 1114
CXH51-140-538Y	1		538 / 646	22	878	79,4	3 1/8"	104,0	4 1/8"	221	159,36	587 / 921
CXH92-180-545Y	2		545 / 654	36	1475	79,4	3 1/8"	104,0	4 1/8"	332	262,20	465 / 1442
CXH91-160-620Y	1	⑥ ⑦	620 / 744	36	1475	79,4	3 1/8"	104,0	4 1/8"	283	186,48	436 / 1364
CXH92-210-620Y	2		620 / 744	36	1490	79,4	3 1/8"	104,0	4 1/8"	375	286,32	586 / 1853
CXH91-180-702Y	1		702 / 842	36	1475	79,4	3 1/8"	104,0	4 1/8"	315	208,20	465 / 1442
CXH92-240-702Y	2		702 / 842	36	1490	79,4	3 1/8"	104,0	4 1/8"	427	318,60	650 / 2029
CXH91-210-810Y	1		810 / 972	36	1475	104,0	4 1/8"	DN125		356	242,88	586 / 1853
CXH92-280-810Y	2		810 / 972	36	1490	104,0	4 1/8"	DN125		455	350,40	805 / 2520
CXH91-240-912Y	1		912 / 1094	36	1490	104,0	4 1/8"	DN125		427	259,32	650 / 2029
CXH92-300-912Y	2		912 / 1094	36	1490	104,0	4 1/8"	DN125		474	371,88	805 / 2520

- ① Controllo di capacità:
100-25% modulante / 100-75-50-25% gradini
- ② Vedi limiti di applicazione a pag.6 e 7
- ③ 50 Hz; 2900 min⁻¹ / 60 Hz; 3500 min⁻¹
- ④ Olio POE FRASCOLD FC170
- ⑤ Il peso netto include: flangia di aspirazione con codolo di collegamento; rubinetto di compressione. Rubinetto di aspirazione (optional).
- ⑥ Per la selezione dei contattori, i cavi di alimentazione e i fusibili, tenere conto della massima corrente operativa.
- ⑦ CXH01, CXH02, CXH51, CXH52:
dati per Δ/ Δ Δ PWS (Part Winding Start).
Versione √/ Δ a richiesta.
CXH91, CXH 92: dati per versione √/ Δ.

- ① Capacity control:
100-25% floating / 100-75-50-25% steps
- ② See pag.6 and 7 "Application limits"
- ③ 50 Hz; 2900 min⁻¹ / 60 Hz; 3500 min⁻¹
- ④ Lubricant POE FRASCOLD FC170
- ⑤ Net weight includes: suction flange and sleeve; discharge valve. Suction valve (optional).
- ⑥ Consider maximum operating current for contactors, cables and fuses dimensioning.
- ⑦ CXH01, CXH02, CXH51, CXH52:
data for Δ/ Δ Δ PWS (Part Winding Start).
Version √/ Δ upon request.
CXH91, CXH 92: data for √/ Δ version.

- ① Leistungsregelung Stufenlose odeer alternativ 4-stufige
- ② Siehe "Einsatzgrenzen" Seite 6 und 7
- ③ 50 Hz; 2900 min⁻¹ / 60 Hz; 3500 min⁻¹
- ④ Schmierölfüllung POE FRASCOLD FC170
- ⑤ Netto Gewicht mit Saugseitiger Anschluß mit Flansch und Löbüchse, Druckventil. Saugventil (option)
- ⑥ Für die Auslegung von Schützen, Zuleitungen und Sicherungen max. Betriebsstrom berücksichtigen.
- ⑦ CXH01, CXH02, CXH51, CXH52:
Daten für Δ/ Δ Δ PWS (Part Winding).
Ausführung auf Anfrage.
CXH91, CXH 92: Daten für √/ Δ.

Limiti operativi Operating limits Einsatzgrenzen

Il funzionamento dei compressori è possibile all'interno dei diagrammi di applicazione; prestare attenzione alle aree colorate. Per i limiti operativi di ogni singolo compressore, consultare il software FRASCOLD FSS.

Compressor operation is possible within the limits shown on the application diagrams, please note the coloured areas. For the operating limits of each compressor, please see FRASCOLD selection software FSS.

Der Betrieb von Verdichter Können innerhalb von Diagramme Anwendung; Vorsichtin auf die farbigen Flächen. Für die Einsatzgrenzen der einzelnen Verdichter, siehe Frascold selection software FSS.

R134a motore - motor - motor 1 senza economizzatore - without economiser - ohne Economizer

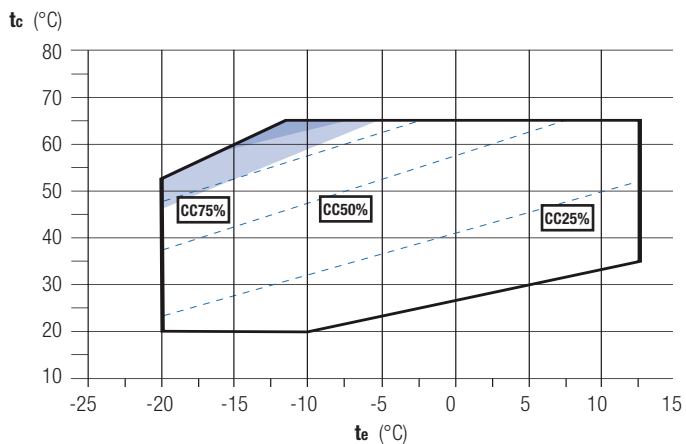

R134a motore - motor - motor 1 con economizzatore - with economiser - mit Economizer

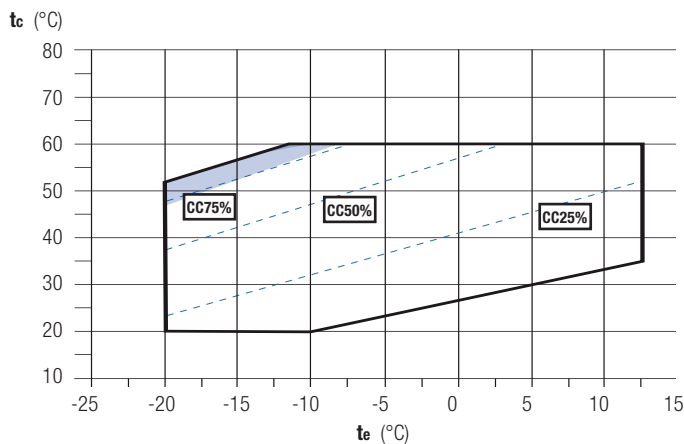

R134a motore - motor - motor 2 senza economizzatore - without economiser - ohne Economizer

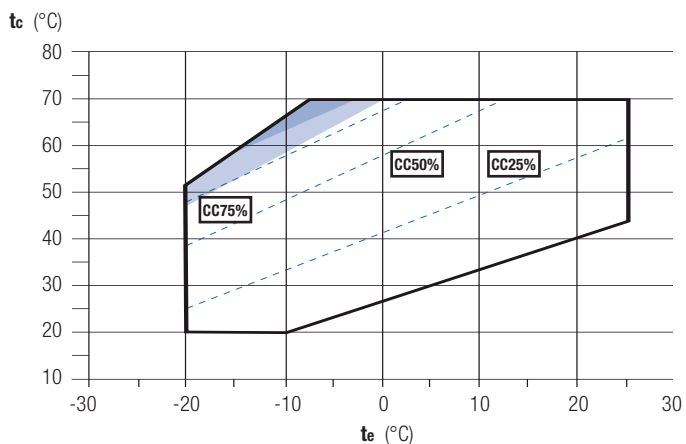

R134a motore - motor - motor 2 con economizzatore - with economiser - mit Economizer

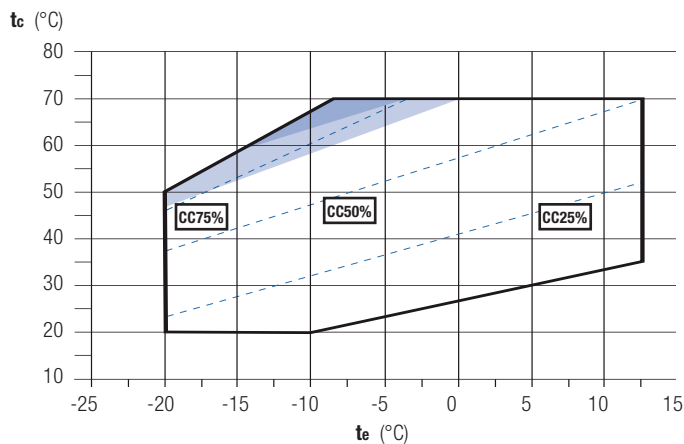

R404A motore - motor - motor 2 senza economizzatore - without economiser - ohne Economizer

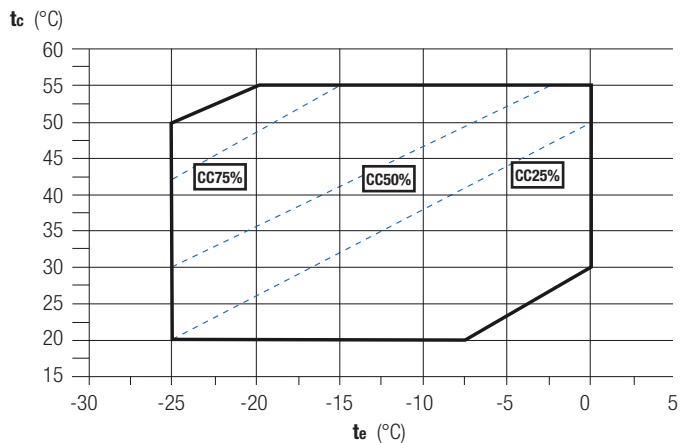

R404A motore - motor - motor 2 con economizzatore - with economiser - mit Economizer

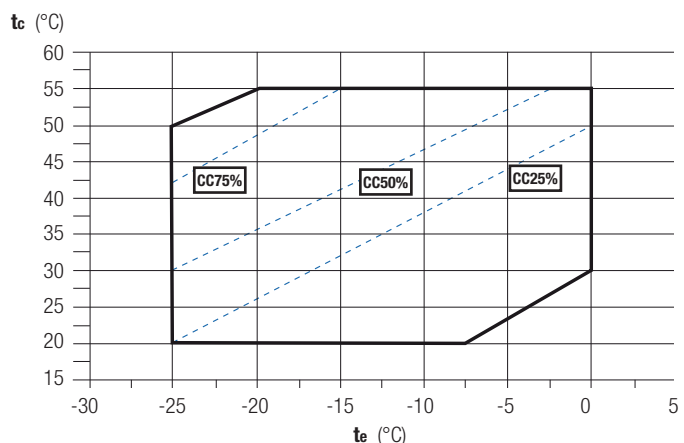

Limiti operativi Operating limits Einsatzgrenzen

Il funzionamento dei compressori è possibile all'interno dei diagrammi di applicazione; prestare attenzione alle aree colorate. Per i limiti operativi di ogni singolo compressore, consultare il software FRASCOLD FSS.

Compressor operation is possible within the limits shown on the application diagrams, please note the coloured areas. For the operating limits of each compressor, please see FRASCOLD selection software FSS.

Der Betrieb von Verdichtern können innerhalb von Diagramme Anwendung; Vorsichtin auf die farbigen Flächen. Für die Einsatzgrenzen der einzelnen Verdichter, siehe

R407C motore - motor - motor 2 senza economizzatore - without economiser - ohne Economizer

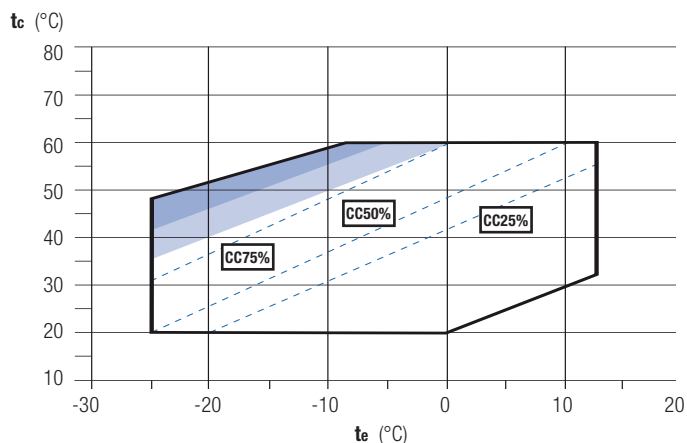

R407C motore - motor - motor 2 con economizzatore - with economiser - mit Economizer

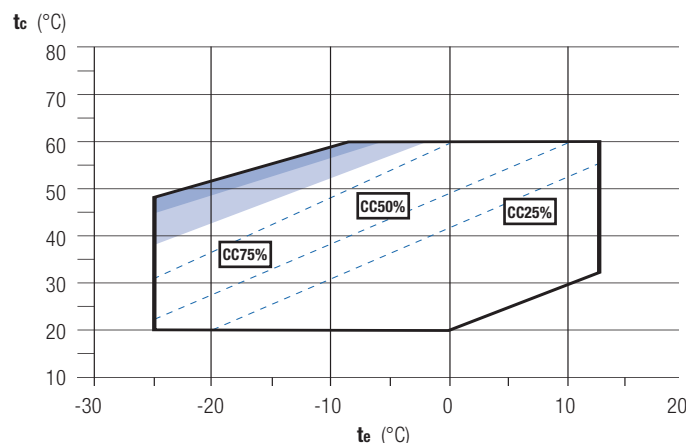

R22 motore - motor - motor 2 senza economizzatore - without economiser - ohne Economizer

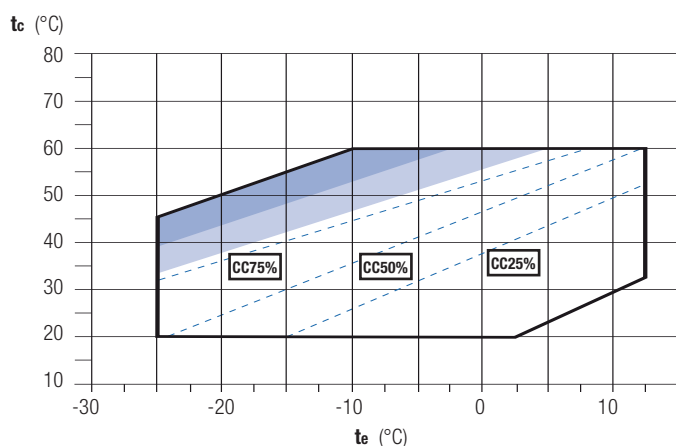

R22 motore - motor - motor 2 con economizzatore - with economiser - mit Economizer

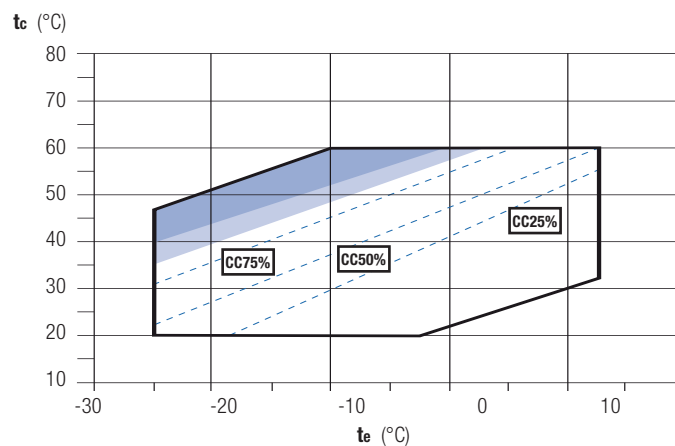

I valori riportati nelle tabelle da pagina 8 e i limiti di impiego sono stati calcolati alle seguenti condizioni:

- surriscaldamento gas aspirato 10K
- senza sottoraffreddamento del liquido

tc = temperatura di condensazione (°C)

te = temperatura di evaporazione (°C)

funzionamento a pieno carico (100%)

CC funzionamento a carico ridotto

con raffreddatore d'olio o iniezione di liquido

con raffreddatore d'olio

Performance data quoted from pag.8 and application limits are calculated with following conditions:

- suction gas superheating 10K
- without liquid subcooling

tc = condensing temperature (°C)

te = evaporating temperature (°C)

full load operation (100%)

CC partial load operation

with oil cooler or liquid injection

with oil cooler

Die von Seite 8 gezeigten Leistungswerte und Anwendungsgrenzen basieren auf den folgenden Bedingungen:

- Sauggasüberhitzung 10K
- ohne Flüssigkeitsunterkühlung

tc = Verflüssigungstemperatur (°C)

te = Verdampfungstemperatur (°C)

Vollastbetrieb (100%)

CC Teilastbetrieb

mit Ölkühler oder Flüssigkeitseinspritzung

mit Ölkühler

R134a • 50 Hz

Senza economizzatore Without economiser Ohne Economizer

Prestazioni Performance Leistungswerte

Dati riferiti con surriscaldamento 10 K, senza sottoraffreddamento del liquido

Data referred to 10 K superheat, without liquid subcooling

Bezogen auf 10 K Sauggas-Überhitzung, ohne Flüssigkeits-Unterkühlung

Compressore Compressor Verdichter	Condensazione Condensing Verflüssigungs- temperatur °C	Q _o (Watt) P _e (kW) 50 Hz ↓	Potenza frigorifera Potenza assorbita		Cooling capacity Power consumption		Kälteleistung Leistungsaufnahme	
			Temperatura di evaporazione °C		Evaporating temperature °C		Verdampfungstemperatur °C	
			10	5	0	-5	-10	-15
CXH01-50-199Y	30	Q _o	147830	120810	97666	77985	61354	
		P _e	25,54	25,03	24,26	23,43	22,69	
	40	Q _o	159479	130578	105672	84348	66192	50792
		P _e	31,44	30,52	29,40	28,27	27,30	26,66
	50	Q _o	136644	110617	88291	69253	53089	39387
		P _e	37,02	35,67	34,37	33,28	32,58	32,45
	60	Q _o	111415	88730	69451	53165	39459	
		P _e	44,01	42,66	41,57	40,93	40,92	
CXH01-60-230Y	30	Q _o	172903	141777	115063	92278	72940	
		P _e	28,06	27,18	26,42	25,78	25,26	
	40	Q _o	187197	154088	125471	100866	79791	61764
		P _e	34,65	33,46	32,38	31,43	30,59	29,86
	50	Q _o	162738	132731	106816	84514	65342	48817
		P _e	41,45	40,17	39,01	37,96	37,01	36,17
	60	Q _o	135506	108793	85775	65968	48891	
		P _e	50,28	49,02	47,86	46,80	45,85	
CXH01-70-264Y	30	Q _o	194039	159092	129208	103852	82493	
		P _e	32,29	30,82	29,57	28,60	27,94	
	40	Q _o	210281	173167	141188	113813	90509	70742
		P _e	40,54	38,55	36,82	35,36	34,24	33,49
	50	Q _o	183575	150152	121406	96805	75816	57906
		P _e	48,02	46,00	44,28	42,90	41,91	41,35
	60	Q _o	154967	125499	100250	78688	60279	
		P _e	58,37	56,59	55,17	54,15	53,58	
CXH01-80-298Y	30	Q _o	223623	183292	148824	119589	94956	
		P _e	37,91	35,54	33,92	32,78	31,83	
	40	Q _o	242523	199237	162056	130351	103493	80852
		P _e	46,91	44,31	42,47	41,14	40,03	38,88
	50	Q _o	212012	172359	138426	109583	85200	64649
		P _e	55,63	53,40	51,68	50,22	48,74	46,96
	60	Q _o	178379	142457	111869	85986	64176	
		P _e	66,90	64,62	62,62	60,62	58,34	
CXH01-90-340Y	30	Q _o	244064	200627	163566	132196	105827	
		P _e	42,00	40,04	38,56	37,44	36,57	
	40	Q _o	266537	219644	179389	145085	116044	91578
		P _e	51,21	49,36	47,85	46,58	45,43	44,30
	50	Q _o	235439	192329	155430	124054	97514	75123
		P _e	61,79	60,08	58,48	56,88	55,17	53,25
	60	Q _o	200807	161651	128279	100004	76138	
		P _e	75,99	73,89	71,66	69,19	66,38	
CXH01-100-370Y	30	Q _o	265603	218332	178001	143862	115166	
		P _e	45,70	43,58	41,97	40,74	39,79	
	40	Q _o	290058	239027	195220	157889	126285	99659
		P _e	55,72	53,71	52,07	50,69	49,44	48,21
	50	Q _o	256217	209302	169146	135002	106120	81752
		P _e	67,24	65,38	63,64	61,90	60,04	57,95
	60	Q _o	218528	175917	139600	108830	82857	
		P _e	82,70	80,41	77,98	75,30	72,24	
CXH51-110-398Y	30	Q _o	307919	252588	205460	165681	132400	
		P _e	48,11	46,58	45,16	43,82	42,50	
	40	Q _o	335792	276722	226012	182808	146258	115510
		P _e	59,84	58,08	56,49	55,01	53,61	52,25
	50	Q _o	295067	241717	196031	157156	124239	96427
		P _e	71,86	70,05	68,42	66,91	65,49	64,09
	60	Q _o	249999	202773	162514	128371	99490	
		P _e	86,85	85,03	83,39	81,87	80,44	
CXH51-125-468Y	30	Q _o	352566	290065	236462	190775	152022	
		P _e	59,03	55,23	52,36	50,22	48,62	
	40	Q _o	384560	316789	258406	208428	165875	129763
		P _e	71,52	67,58	64,41	61,81	59,60	57,59
	50	Q _o	338558	276003	222343	176597	137783	104919
		P _e	83,20	79,85	76,92	74,22	71,56	68,75
	60	Q _o	287945	231211	182881	141972	107503	
		P _e	99,28	96,13	93,06	89,88	86,39	

Vedi nota a pagina 9

See notes on page 9

Siehe Notes auf Seite 9

R134a • 50 Hz

Senza economizzatore Without economiser Ohne Economizer

Prestazioni Performance Leistungswerte

Dati riferiti con surriscaldamento 10 K, senza sottoraffreddamento del liquido

Data referred to 10 K superheat, without liquid subcooling

Bezogen auf 10 K Sauggas-Überhitzung, ohne Flüssigkeits-Unterkühlung

Compressore Compressor Verdichter	Condensazione Condensing Verflüssigungs- temperatur °C	Q _o (Watt) P _e (kW) 50 Hz ↓	Potenza frigorifera ⑧ ⑨ Potenza assorbita ⑧ ⑨		Cooling capacity ⑧ ⑨ Power consumption ⑧ ⑨		Kälteleistung ⑧ ⑨ Leistungsaufnahme ⑧ ⑨	
			Temperatura di evaporazione °C		Evaporating temperature °C		Verdampfungstemperatur °C	
			10	5	0	-5	-10	-15
CXH51-140-538Y	30	Q _o	401754	330543	269610	217857	174184	
		P _e	65,29	62,76	60,38	58,17	56,17	
	40	Q _o	437541	361217	295578	239525	191958	151780
		P _e	79,81	76,98	74,38	72,05	70,02	68,33
	50	Q _o	387320	317549	257770	206884	163793	127397
		P _e	95,84	92,69	89,90	87,50	85,53	84,03
	60	Q _o	333844	270913	217282	171853	133525	
		P _e	116,97	113,38	110,27	107,69	105,67	
CXH91-160-620Y	30	Q _o	470647	386630	314309	252314	199280	
		P _e	74,29	72,03	70,03	68,31	66,92	
	40	Q _o	513139	422672	344513	277294	219647	170205
		P _e	91,46	88,45	85,67	83,14	80,89	78,96
	50	Q _o	449909	367211	296066	235106	182963	138272
		P _e	109,00	105,75	102,72	99,93	97,42	95,23
	60	Q _o	379295	305523	242548	189004	143522	
		P _e	131,24	128,01	125,00	122,23	119,74	
CXH91-180-702Y	30	Q _o	537982	444348	363757	294678	235582	
		P _e	83,06	80,52	78,36	76,25	73,83	
	40	Q _o	587226	485981	398517	323302	258808	203504
		P _e	102,34	100,17	98,39	96,68	94,68	92,06
	50	Q _o	519825	426842	346846	278309	219699	169487
		P _e	124,70	122,80	120,98	118,89	116,19	112,55
	60	Q _o	445997	362576	291350	230789	179364	
		P _e	153,29	150,84	148,15	144,87	140,66	
CXH91-210-810Y	30	Q _o	607346	49620	407437	329114	262969	
		P _e	96,92	93,72	90,94	88,45	86,09	
	40	Q _o	664057	547897	447990	362653	290204	228961
		P _e	121,69	117,22	113,33	109,89	106,74	103,75
	50	Q _o	588631	481969	390588	312805	246938	191304
		P _e	145,27	140,27	135,88	131,96	128,35	124,91
	60	Q _o	506744	410287	328139	258617	200038	
		P _e	173,97	168,64	163,93	159,70	155,80	
CXH91-240-912Y	30	Q _o	663914	545574	444309	358294	285703	
		P _e	104,98	102,26	99,26	96,21	93,33	
	40	Q _o	725866	598638	489156	395595	316129	248932
		P _e	131,73	127,58	123,45	119,56	116,15	113,43
	50	Q _o	643912	527739	428157	343342	271466	210704
		P _e	158,97	153,57	148,71	144,62	141,52	139,63
	60	Q _o	555943	451866	363226	288198	224954	
		P _e	190,80	184,83	179,92	176,30	174,19	

- ⑧ Per dati di prestazione in punti operativi diversi vedi Frascold Selection Software.
- ⑨ Sono riportati solo i dati dei modelli con motore taglia 1. Per i dati di prestazione dei modelli con motore taglia 2 vedi Frascold Selection Software.

- ⑧ Performance data for individual conditions see Frascold Selection Software.
- ⑨ Data referred to models with motor size 1. For data of the models with motor size 2 see Frascold Selection Software.

- ⑧ Leistungsdaten für individuelle Betriebsbedingungen siehe Frascold Selection Software.
- ⑨ Daten gelten für Verdichter mit Motor Version 1. Für Verdichter mit Motor Version 2 siehe Frascold Selection Software.

Con raffreddatore d'olio

With oil cooler

Mit Ölkühler

R134a • 50 Hz

Con economizzatore With economiser Mit Economizer

Prestazioni Performance Leistungswerte

Dati riferiti con surriscaldamento 10 K, con sottoraffreddamento del liquido

Data referred to 10 K superheat, with liquid subcooling

Bezogen auf 10 K Sauggas-Überhitzung, mit Flüssigkeits-Unterkuhlung

Compressore Compressor Verdichter	Condensazione Condensing Verflüssigungs- temperatur °C	Q _o (Watt) P _e (kW) 50 Hz ↓	Potenza frigorifera Potenza assorbita		Cooling capacity Power consumption		Kälteleistung Leistungsaufnahme	
			Temperatura di evaporazione °C		Evaporating temperature °C		Verdampfungstemperatur °C	
			10	5	0	-5	-10	-15
CXH01-50-199Y	30	Q _o	156801	131754	109688	90315	73347	
		P _e	26,40	26,28	25,95	25,53	25,15	
	40	Q _o	173838	146559	122363	100962	82068	65392
		P _e	33,04	32,74	32,22	31,62	31,05	30,64
	50	Q _o	158347	132541	109631	89330	71349	55399
		P _e	40,79	40,20	39,52	38,87	38,38	38,17
60	Q _o			93869	75102	58468		
	P _e			49,76	49,29	49,11		
CXH01-60-230Y	30	Q _o	180921	152347	127227	105167	85777	
		P _e	28,86	28,38	28,11	28,01	28,02	
	40	Q _o	200661	169794	142462	118271	96831	77747
		P _e	36,16	35,75	35,45	35,19	34,92	34,58
	50	Q _o	184096	154987	129100	106044	85427	68855
		P _e	45,55	45,37	45,14	44,77	44,23	43,43
60	Q _o	163240	136092	111856	90139	70549		
	P _e	58,66	58,61	58,33	57,75	56,81		
CXH01-70-264Y	30	Q _o	197724	166930	139804	115982	95103	
		P _e	32,49	31,49	30,80	30,34	30,08	
	40	Q _o	219708	186352	156785	130646	107572	87200
		P _e	41,20	39,82	38,79	38,07	37,58	37,28
	50	Q _o	202692	171257	143372	118675	96803	77393
		P _e	50,48	49,26	48,39	47,82	47,49	47,35
60	Q _o	181884	152826	127077	104276	84061		
	P _e	63,84	62,97	62,45	62,23	62,25		
CXH01-80-298Y	30	Q _o	232925	195467	162836	134519	109999	
		P _e	38,72	36,79	35,74	35,20	34,82	
	40	Q _o	257757	217063	181428	150339	123278	99732
		P _e	48,64	46,86	45,89	45,37	44,93	44,23
	50	Q _o	236127	197606	163862	134378	108641	86134
		P _e	60,23	59,24	58,64	58,05	57,13	55,53
60	Q _o	209727	173445	141656	113845	89497		
	P _e	76,01	75,22	74,39	73,16	71,17		
CXH01-90-340Y	30	Q _o	248355	209519	175576	146026	120368	
		P _e	42,20	40,69	39,76	39,25	38,99	
	40	Q _o	277119	234448	196977	164204	135629	110751
		P _e	52,00	50,83	50,06	49,54	49,09	48,56
	50	Q _o	256816	216012	180213	148918	121624	97833
		P _e	64,40	63,69	63,05	62,32	61,32	59,89
60	Q _o	230629	192000	158181	128670	102966		
	P _e	81,50	80,64	79,51	77,94	75,78		
CXH01-100-370Y	30	Q _o	270272	228009	191071	158913	130990	
		P _e	45,93	44,28	43,27	42,71	42,43	
	40	Q _o	301574	255139	214361	178696	147598	120524
		P _e	56,59	55,31	54,48	53,91	53,42	52,84
	50	Q _o	279480	235076	196117	162060	132358	106467
		P _e	70,09	69,31	68,62	67,82	66,73	65,18
60	Q _o	250982	208944	172140	140025	112053		
	P _e	88,69	87,75	86,52	84,82	82,46		
CXH51-110-398Y	30	Q _o	313305	264643	221920	184594	152121	
		P _e	48,39	47,50	46,83	46,24	45,57	
	40	Q _o	350478	297560	250797	209648	173567	142011
		P _e	60,92	60,12	59,58	59,14	58,66	57,98
	50	Q _o	325799	275796	231622	192732	158584	128633
		P _e	75,62	75,22	74,95	74,67	74,21	73,43
60	Q _o	293572	247171	206272	170330	138802		
	P _e	94,84	94,75	94,67	94,45	93,94		
CXH51-125-468Y	30	Q _o	367456	309919	259493	215398	176856	
		P _e	60,19	57,09	55,02	53,72	52,94	
	40	Q _o	409615	346285	290540	241601	198689	161023
		P _e	73,94	71,09	69,01	67,44	66,11	64,77
	50	Q _o	378943	318333	265004	218176	177068	140902
		P _e	88,93	87,11	85,54	83,94	82,06	79,64
60	Q _o	341514	284248	233957	189861	151181		
	P _e	109,92	108,61	107,02	104,88	101,93		

Ⓢ Ⓣ Vedi nota a pagina 11

Ⓢ Ⓣ See notes on page 11

Ⓢ Ⓣ Siehe Notes auf Seite 11

R134a • 50 Hz

Con economizzatore With economiser Mit Economizer

Prestazioni Performance Leistungswerte

Dati riferiti con surriscaldamento 10 K, con sottoraffreddamento del liquido

Data referred to 10 K superheat, with liquid subcooling

Bezogen auf 10 K Sauggas-Überhitzung, mit Flüssigkeits-Unterkühlung

Compressore Compressor Verdichter	Condensazione Condensing Verflüssigungs- temperatur °C	Q _o (Watt) P _e (kW) 50 Hz ↓	Potenza frigorifera ⑧ ⑨ Potenza assorbita ⑧ ⑨		Cooling capacity ⑧ ⑨ Power consumption ⑧ ⑨		Kälteleistung ⑧ ⑨ Leistungsaufnahme ⑧ ⑨	
			Temperatura di evaporazione °C		Evaporating temperature °C		Verdampfungstemperatur °C	
			10	5	0	-5	-10	-15
CXH51-140-538Y	30	Q _o	408468	344942	289233	240558	198136	
		P _e	65,77	63,90	62,29	60,92	59,74	
	40	Q _o	454674	385520	324632	271226	224523	183741
		P _e	80,95	79,15	77,67	76,47	75,51	74,75
	50	Q _o	422928	357246	299496	248898	204670	166029
		P _e	99,75	98,04	96,66	95,57	94,72	94,08
	60	Q _o	385004	323297	269190	221901	180650	
		P _e	125,42	123,50	121,92	120,63	119,60	
CXH91-160-620Y	30	Q _o	492072	415086	347151	287154	233987	
		P _e	76,04	74,94	74,22	73,75	73,36	
	40	Q _o	549247	464931	390334	324346	265855	213752
		P _e	94,96	93,58	92,52	91,63	90,77	89,77
	50	Q _o	507328	427211	356372	293700	238084	188414
		P _e	117,56	116,41	115,38	114,30	113,02	111,39
	60	Q _o	454179	379630	313918	255931	204559	
		P _e	147,54	146,61	145,57	144,27	142,55	
CXH91-180-702Y	30	Q _o	547597	465715	392973	328310	270666	
		P _e	83,66	82,19	81,32	80,55	79,40	
	40	Q _o	612794	521980	441270	369601	305915	249148
		P _e	104,20	103,62	103,58	103,60	103,20	101,90
	50	Q _o	571730	484358	406992	338570	278032	224315
		P _e	130,81	131,16	131,53	131,44	130,40	127,93
	60	Q _o	519203	437446	365597	302594	247376	
		P _e	166,16	166,43	166,19	164,96	162,26	
CXH91-210-810Y	30	Q _o	632077	532293	445267	369608	303926	
		P _e	98,75	96,92	95,58	94,44	93,25	
	40	Q _o	704825	595775	500249	416855	344204	280905
		P _e	125,63	122,99	120,96	119,28	117,66	115,85
	50	Q _o	653213	549974	459634	380802	312088	252102
		P _e	154,70	152,07	149,92	147,97	145,95	143,60
	60	Q _o	591267	494768	410544	337203	273355	
		P _e	191,29	188,76	186,57	184,43	182,09	
CXH91-240-912Y	30	Q _o	675157	569592	476951	395914	325161	
		P _e	105,48	104,03	102,47	100,86	99,25	
	40	Q _o	754288	638495	536533	447082	368825	300440
		P _e	133,78	131,36	129,13	127,12	125,39	123,98
	50	Q _o	700949	591118	494706	410395	336864	272795
		P _e	165,58	162,59	160,12	158,20	156,89	156,25
	60	Q _o	636253	534331	445418	368193	301338	
		P _e	204,00	200,99	198,82	197,55	197,21	

- ⑧ Per dati di prestazione in punti operativi diversi vedi Frascold Selection Software.
- ⑨ Sono riportati solo i dati dei modelli con motore taglia 1. Per i dati di prestazione dei modelli con motore taglia 2 vedi Frascold Selection Software.

- ⑧ Performance data for individual conditions see Frascold Selection Software.
- ⑨ Data referred to models with motor size 1. For data of the models with motor size 2 see Frascold Selection Software.

- ⑧ Leistungsdaten für individuelle Betriebsbedingungen siehe Frascold Selection Software.
- ⑨ Daten gelten für Verdichter mit Motor Version 1. Für Verdichter mit Motor Version 2 siehe Frascold Selection Software.

Con raffreddatore d'olio

With oil cooler

Mit Ölkühler

R407C • 50 Hz

Senza economizzatore Without economiser Ohne Economizer

Prestazioni Performance Leistungswerte

Dati riferiti con surriscaldamento 10 K, senza sottoraffreddamento del liquido

Data referred to 10 K superheat, without liquid subcooling

Bezogen auf 10 K Sauggas-Überhitzung, ohne Flüssigkeits-Unterkuhlung

Compressore Compressor Verdichter	Condensazione Condensing Verflüssigungs- temperatur °C	Q _o (Watt) P _e (kW) 50 Hz ↓	Potenza frigorifera ⑧ Potenza assorbita ⑧		Cooling capacity ⑧ Power consumption ⑧		Kälteleistung ⑧ Leistungsaufnahme ⑧		
			Temperatura di evaporazione °C		Evaporating temperature °C		Verdampfungstemperatur °C		
			10	5	0	-5	-10	-15	-20
CXH02-70-199Y	30	Q _o	247907	205402	170054	140439	115134	92714	71757
		P _e	38,17	35,78	33,96	32,62	31,62	30,85	30,19
	40	Q _o	220461	182225	150264	123155	99474	77797	56702
		P _e	45,15	43,56	42,26	41,16	40,12	39,02	37,75
	50	Q _o	190452	156365	127671	102947	80770	59716	38362
		P _e	55,14	53,95	52,79	51,52	50,04	48,22	45,94
	55	Q _o	174683	142624	115518	91942	70471	49683	
		P _e	61,00	59,87	58,61	57,12	55,26	52,93	
CXH02-80-230Y	30	Q _o	285254	237789	197122	162388	132726	107271	85161
		P _e	43,85	41,52	39,72	38,32	37,15	36,08	34,93
	40	Q _o	255379	211208	173633	141791	114820	91856	72036
		P _e	51,22	49,47	48,18	47,20	46,38	45,56	44,61
	50	Q _o	220431	180538	147041	119077	95781	76293	59748
		P _e	61,75	60,47	59,57	58,91	58,32	57,67	56,79
	55	Q _o	201827	164442	133353	107696	86609	69227	
		P _e	68,44	67,36	66,62	66,07	65,56	64,95	
CXH02-90-264Y	30	Q _o	330824	275769	228483	188104	153774	124633	99821
		P _e	49,62	47,31	45,33	43,62	42,12	40,79	39,56
	40	Q _o	295940	244814	201228	164320	133233	107105	85077
		P _e	58,41	56,40	54,75	53,41	52,32	51,43	50,68
	50	Q _o	255560	209337	170425	137963	111091	88950	70680
		P _e	71,05	69,45	68,25	67,39	66,81	66,47	66,31
	55	Q _o	234087	190681	154471	124596	100197	80415	
		P _e	79,50	78,14	77,20	76,62	76,34	76,32	
CXH02-100-298Y	30	Q _o	375219	312616	259142	213546	174582	141001	111554
		P _e	55,11	52,16	49,92	48,17	46,68	45,19	43,48
	40	Q _o	335859	277644	228275	186502	151078	120754	94282
		P _e	64,52	62,22	60,59	59,40	58,40	57,36	56,04
	50	Q _o	289848	237329	193372	156730	126153	100394	78205
		P _e	78,57	76,94	75,92	75,28	74,78	74,19	73,27
	55	Q _o	265355	216174	175414	141827	114164	91178	
		P _e	87,93	86,63	85,92	85,56	85,31	84,94	
CXH52-110-316Y	30	Q _o	400385	333583	276872	228131	185235	146061	108486
		P _e	60,13	56,57	53,66	51,36	49,62	48,37	47,57
	40	Q _o	366809	303157	249511	203748	163744	127376	92521
		P _e	70,53	68,20	66,17	64,39	62,81	61,39	60,06
	50	Q _o	329067	267709	216271	172629	134661	100243	67250
		P _e	85,64	83,78	81,86	79,85	77,70	75,33	72,72
	55	Q _o	305597	245065	194409	151508	114236	80471	
		P _e	95,11	93,19	91,06	88,65	85,91	82,80	
CXH02-120-340Y	30	Q _o	439202	367182	304574	250435	203818	163779	129373
		P _e	64,70	60,87	57,74	55,26	53,37	52,03	51,19
	40	Q _o	395366	328871	270937	220620	176975	139055	105918
		P _e	75,91	73,40	71,21	69,29	67,58	66,04	64,61
	50	Q _o	344554	283307	229770	182997	142045	105968	73820
		P _e	92,16	90,17	88,11	85,94	83,61	81,06	78,24
	55	Q _o	315620	256892	205449	160345	120635	85375	
		P _e	102,33	100,29	98,00	95,41	92,46	89,10	
CXH52-125-372Y	30	Q _o	488743	407808	337407	276601	224452	180022	142373
		P _e	72,10	68,12	65,10	62,60	60,20	57,46	53,96
	40	Q _o	436396	363317	299441	243829	195544	153648	117201
		P _e	84,99	81,17	78,24	75,77	73,34	70,51	66,85
	50	Q _o	372246	307664	250954	201178	157398	118676	84072
		P _e	101,17	97,08	93,81	90,94	88,04	84,68	80,44
	55	Q _o	336835	276742	223856	177238	135951	99056	
		P _e	109,96	105,56	101,97	98,73	95,44	91,66	
CXH52-140-428Y	30	Q _o	565642	472241	391080	320980	260762	209247	165256
		P _e	81,49	77,21	73,71	70,78	68,26	65,94	63,66
	40	Q _o	502399	418964	346323	283296	228705	181369	140110
		P _e	96,81	92,58	89,12	86,25	83,79	81,55	79,34
	50	Q _o	431701	358120	293885	237817	188738	145468	106828
		P _e	116,88	112,52	108,95	105,97	103,40	101,06	98,77
	55	Q _o	395027	326329	266254	213624	167259	125979	
		P _e	128,83	124,35	120,66	117,56	114,88	112,43	

⑧ Vedi nota a pagina 13

⑧ See notes on page 13

⑧ Siehe Notes auf Seite 13

R407C • 50 Hz

Senza economizzatore Without economiser Ohne Economizer

**Prestazioni
Performance
Leistungswerte**

Dati riferiti con surriscaldamento 10 K, senza sottoraffreddamento del liquido
Data referred to 10 K superheat, without liquid subcooling
Bezogen auf 10 K Sauggas-Überhitzung, ohne Flüssigkeits-Unterkühlung

Compressore Compressor Verdichter	Condensazione Condensing Verflüssigungs- temperatur °C	Q _o (Watt) P _e (kW) 50 Hz	Potenza frigorifera ⑧ Potenza assorbita ⑧			Cooling capacity ⑧ Power consumption ⑧			Kälteleistung ⑧ Leistungsaufnahme ⑧	
			Temperatura di evaporazione °C			Evaporating temperature °C			Verdampfungstemperatur °C	
			10	5	0	-5	-10	-15	-20	
CXH52-160-468Y	30	Q _o	611019	510409	422707	346791	281540	225834	178552	
		P _e	88,59	83,69	79,92	77,00	74,66	72,59	70,52	
	40	Q _o	545701	455041	375875	307083	247543	196135	151738	
		P _e	105,95	101,02	97,09	93,87	91,07	88,40	85,59	
	50	Q _o	470485	390403	320403	259364	206164	159683	118800	
		P _e	128,10	123,30	119,35	115,95	112,84	109,71	106,29	
	55	Q _o	429674	355118	289937	233010	183216	139434		
		P _e	139,87	135,18	131,27	127,84	124,62	121,31		
	CXH92-180-545Y	30	Q _o	705031	589417	488858	401909	327120	263046	208239
			P _e	102,34	96,51	91,87	88,21	85,29	82,89	80,78
		40	Q _o	635134	528226	435018	354061	283908	223113	170227
			P _e	120,78	116,76	113,30	110,20	107,21	104,11	100,68
50		Q _o	553023	454642	368603	293459	227763	170066	118922	
		P _e	147,19	143,92	140,58	136,97	132,84	127,98	122,16	
55		Q _o	506320	412135	329614	257309	193773	137559		
		P _e	162,93	159,63	155,96	151,69	146,60	140,46		
CXH92-210-620Y		30	Q _o	813018	679827	564048	464000	378003	304376	241439
			P _e	119,19	111,92	106,41	102,02	98,11	94,05	89,19
		40	Q _o	728177	605947	499397	406848	326619	257029	196399
			P _e	140,33	133,95	128,97	124,75	120,63	115,99	110,19
	50	Q _o	627690	517205	420670	336404	262728	197961	140422	
		P _e	169,05	162,74	157,46	152,56	147,40	141,36	133,78	
	55	Q _o	571731	467413	376180	296351	226246	164184		
		P _e	185,58	179,00	173,25	167,70	161,72	154,65		
	CXH92-240-702Y	30	Q _o	915690	765720	635292	522577	425746	342972	272425
			P _e	132,62	124,88	118,91	114,11	109,84	105,49	100,43
		40	Q _o	818964	682799	564124	461112	371932	294758	227761
			P _e	157,31	150,09	144,53	139,99	135,86	131,52	126,34
50		Q _o	709176	587647	481557	389077	308380	237636	175018	
		P _e	190,05	183,25	177,97	173,59	169,48	165,04	159,63	
55		Q _o	649718	535818	436332	349430	273285	206069		
		P _e	210,13	203,50	198,31	193,97	189,84	185,30		
CXH92-280-810Y		30	Q _o	1048226	877884	729669	601376	490798	395727	313958
			P _e	152,24	142,84	135,27	129,28	124,63	121,08	118,37
		40	Q _o	942604	785260	648158	529092	425855	336240	258041
			P _e	178,49	171,16	164,81	159,21	154,10	149,25	144,41
	50	Q _o	822776	678662	552905	443298	347634	263706	189308	
		P _e	215,29	208,19	201,24	194,19	186,81	178,83	170,03	
	55	Q _o	756618	619207	499209	394418	302628	221631		
		P _e	236,74	229,07	221,14	212,69	203,48	193,26		
	CXH92-300-912Y	30	Q _o	1171798	981375	815647	672198	548610	442468	351355
			P _e	167,75	158,32	150,70	144,48	139,24	134,58	130,08
		40	Q _o	1052338	878228	726611	595073	481197	382566	296764
			P _e	199,04	190,88	184,05	178,14	172,74	167,43	161,82
50		Q _o	922865	765286	628001	508593	404648	313748	233477	
		P _e	241,33	234,03	227,59	221,59	215,62	209,27	202,14	
55		Q _o	853562	704331	574294	461034	362137	275184		
		P _e	266,96	259,95	253,55	247,35	240,95	233,93		

⑧ Per dati di prestazione in punti operativi diversi vedi Frascold Selection Software.

⑧ Performance data for individual conditions see Frascold Selection Software.

⑧ Leistungsdaten für individuelle Betriebsbedingungen siehe Frascold Selection Software.

Con raffreddatore d'olio

With oil cooler

Mit Ölkühler

Con raffreddatore d'olio o iniezione di liquido

With oil cooler or liquid injection

Mit Ölkühler oder Flüssigkeitseinspritzung

R407C • 50 Hz

Con economizzatore With economiser Mit Economizer

Dati riferiti con surriscaldamento 10 K, con sottoraffreddamento del liquido

Data referred to 10 K superheat, with liquid subcooling

Bezogen auf 10 K Sauggas-Überhitzung, mit Flüssigkeits-Unterkuhlung

Prestazioni Performance Leistungswerte

Compressore Compressor Verdichter	Condensazione Condensing Verflüssigungs- temperatur °C	Q _o (Watt) P _e (kW) 50 Hz ↓	Potenza frigorifera Ⓢ Potenza assorbita Ⓢ		Cooling capacity Ⓢ Power consumption Ⓢ		Kälteleistung Ⓢ Leistungsaufnahme Ⓢ		
			Temperatura di evaporazione °C		Evaporating temperature °C		Verdampfungstemperatur °C		
			10	5	0	-5	-10	-15	-20
CXH02-70-199Y	30	Q _o	256558	219731	186956	157876	132136	109378	89246
		P _e	39,27	37,22	36,00	35,36	35,05	34,82	34,41
	40	Q _o	241396	206384	174962	146775	121466	98679	78057
		P _e	47,80	47,12	46,82	46,62	46,28	45,56	44,20
	50	Q _o	222679	188886	158223	130333	104861	81449	59740
		P _e	61,57	61,50	61,33	60,80	59,67	57,68	54,59
	55	Q _o	210981	177574	147067	119102	93325	69377	
		P _e	70,25	70,19	69,80	68,81	66,99	64,08	
CXH02-80-230Y	30	Q _o	297165	254856	217149	183631	153892	127519	104101
		P _e	45,45	43,18	41,91	41,25	40,78	40,11	38,84
	40	Q _o	280453	239845	203406	170724	141388	114986	91106
		P _e	55,65	54,58	54,11	53,84	53,36	52,27	50,18
	50	Q _o	255739	217224	182447	150994	122454	96416	72467
		P _e	71,70	71,11	70,72	70,13	68,92	66,69	63,06
	55	Q _o	240377	203057	169257	138566	110572	84864	
		P _e	81,75	81,13	80,51	79,48	77,64	74,58	
CXH02-90-264Y	30	Q _o	333130	284742	242156	204730	171822	142791	116995
		P _e	50,64	47,95	46,30	45,38	44,87	44,47	43,86
	40	Q _o	311531	266718	226916	191485	159782	131167	104997
		P _e	61,86	59,93	58,78	58,10	57,56	56,85	55,67
	50	Q _o	285208	243814	206642	173050	142397	114042	87342
		P _e	77,08	75,98	75,39	74,99	74,47	73,52	71,82
	55	Q _o	269536	229793	193877	161147	130960	102677	
		P _e	86,91	86,24	85,95	85,72	85,23	84,18	
CXH02-100-298Y	30	Q _o	376005	321403	273341	231097	193951	161179	132062
		P _e	57,16	54,19	52,37	51,38	50,88	50,55	50,04
	40	Q _o	351659	301077	256149	216153	180367	148071	118542
		P _e	69,75	67,56	66,27	65,53	65,01	64,39	63,33
	50	Q _o	321976	275237	233266	195340	160738	128739	98622
		P _e	87,03	85,62	84,83	84,33	83,78	82,87	81,24
	55	Q _o	304289	259405	218846	181888	147812	115896	
		P _e	98,54	97,51	96,97	96,59	96,03	94,96	
CXH52-110-316Y	30	Q _o	420503	359378	306176	259305	217168	178172	140723
		P _e	60,94	58,37	56,73	55,77	55,24	54,89	54,47
	40	Q _o	401171	342034	290439	244792	203500	164967	127599
		P _e	74,81	74,18	73,83	73,52	72,99	72,01	70,31
	50	Q _o	374599	316242	265047	219419	177764	138488	99996
		P _e	96,92	96,99	96,70	95,80	94,04	91,18	86,96
	55	Q _o	356170	297751	246303	200232	157944	117843	
		P _e	110,89	110,84	110,12	108,46	105,62	101,36	
CXH02-120-340Y	30	Q _o	452553	388586	331401	280398	234980	194548	158502
		P _e	65,65	62,84	61,02	59,96	59,40	59,10	58,82
	40	Q _o	431616	369650	313844	263599	218316	177396	140241
		P _e	80,35	79,68	79,34	79,08	78,67	77,85	76,37
	50	Q _o	401895	341225	286094	235901	190049	147938	108969
		P _e	104,04	104,02	103,66	102,73	100,96	98,12	93,97
	55	Q _o	382111	321825	266767	216337	169935	126964	
		P _e	119,60	119,34	118,42	116,58	113,59	109,18	
CXH52-125-372Y	30	Q _o	495032	424802	362166	306452	256988	213103	174125
		P _e	70,60	67,14	65,05	63,83	62,96	61,92	60,20
	40	Q _o	467999	400597	340030	285626	236713	192621	152676
		P _e	86,39	84,38	83,22	82,39	81,40	79,71	76,81
	50	Q _o	428117	364089	306137	253590	205775	162021	121656
		P _e	109,66	108,29	107,23	105,99	104,05	100,89	96,00
	55	Q _o	403184	341048	284609	233195	186134	142755	
		P _e	123,46	122,10	120,79	119,03	116,31	112,11	
CXH52-140-428Y	30	Q _o	542225	465300	396693	335667	281488	233419	190724
		P _e	78,10	74,27	71,97	70,62	69,65	68,50	66,60
	40	Q _o	512615	438787	372446	312855	259280	210984	167231
		P _e	95,57	93,34	92,06	91,15	90,05	88,18	84,97
	50	Q _o	468931	398799	335322	277765	225392	177467	133254
		P _e	121,32	119,80	118,63	117,26	115,11	111,61	106,21
	55	Q _o	441621	373562	311742	255426	203879	156364	
		P _e	136,59	135,07	133,63	131,69	128,68	124,03	

Ⓢ Vedi nota a pagina 15

Ⓢ See notes on page 15

Ⓢ Siehe Notes auf Seite 15

R407C • 50 Hz

Con economizzatore With economiser Mit Economizer

Prestazioni Performance Leistungswerte

Dati riferiti con surriscaldamento 10 K, con sottoraffreddamento del liquido

Data referred to 10 K superheat, with liquid subcooling

Bezogen auf 10 K Sauggas-Überhitzung, mit Flüssigkeits-Unterkühlung

Compressore Compressor Verdichter	Condensazione Condensing Verflüssigungs- temperatur °C	Q _o (Watt) P _e (kW) 50 Hz ↓	Potenza frigorifera ⑧ Potenza assorbita ⑧			Cooling capacity ⑧ Power consumption ⑧			Kälteleistung ⑧ Leistungsaufnahme ⑧	
			Temperatura di evaporazione °C			Evaporating temperature °C			Verdampfungstemperatur °C	
			10	5	0	-5	-10	-15	-20	
CXH52-160-468Y	30	Q _o	606334	518214	440993	373408	314201	262111	215877	
		P _e	88,28	83,57	80,69	79,12	78,31	77,74	76,87	
	40	Q _o	569916	487926	415200	350477	292499	240004	191732	
		P _e	107,87	104,48	102,48	101,35	100,54	99,52	97,77	
	50	Q _o	521975	446542	378741	317309	260988	208518	158637	
		P _e	135,14	133,01	131,83	131,07	130,20	128,69	125,99	
	55	Q _o	493456	421463	356285	296660	241329	189031		
		P _e	152,40	150,88	150,08	149,49	148,57	146,78		
	CXH92-180-545Y	30	Q _o	732825	628367	535250	452442	378909	313617	255533
			P _e	103,54	99,05	96,22	94,58	93,62	92,84	91,76
		40	Q _o	696054	595344	504916	423736	350771	284987	225350
			P _e	127,50	126,08	125,23	124,46	123,29	121,21	117,72
50		Q _o	644387	546585	458004	377611	304373	237255	175225	
		P _e	163,47	163,48	162,97	161,46	158,44	153,42	145,90	
55		Q _o	610734	514070	426097	345782	272092	203992		
		P _e	185,01	185,12	184,18	181,68	177,12	170,02		
CXH92-210-620Y		30	Q _o	833436	714308	608282	514176	430807	356996	291560
			P _e	119,24	114,74	111,09	108,22	106,06	104,52	103,55
		40	Q _o	785125	671058	568857	477341	395330	321641	255094
			P _e	145,57	142,52	140,03	138,04	136,46	135,22	134,25
	50	Q _o	714500	606727	509586	421896	342477	270146	203722	
		P _e	184,36	181,22	178,35	175,68	173,14	170,66	168,15	
	55	Q _o	670829	566666	472518	387205	309544	238356		
		P _e	207,75	203,98	200,35	196,77	193,17	189,48		
	CXH92-240-702Y	30	Q _o	921556	787583	669648	565997	474873	394523	323191
			P _e	131,49	124,90	120,75	118,27	116,64	115,08	112,79
		40	Q _o	861290	737085	626822	528747	441105	362141	290099
			P _e	160,75	155,81	152,74	150,75	149,03	146,80	143,26
50		Q _o	787420	672762	569951	477232	392850	315051	242080	
		P _e	199,88	196,78	194,96	193,64	192,02	189,30	184,69	
55		Q _o	743629	633661	534493	444369	361535	284236		
		P _e	224,50	222,38	221,26	220,35	218,84	215,95		
CXH92-280-810Y		30	Q _o	1063244	910226	774439	654219	547899	453815	370301
			P _e	154,02	146,22	140,72	137,03	134,67	133,16	132,00
		40	Q _o	999372	852730	722026	605595	501771	408889	325283
			P _e	184,43	180,36	177,32	174,85	172,47	169,67	166,00
	50	Q _o	913705	774384	649707	538010	437626	346891	264139	
		P _e	230,98	228,18	225,18	221,50	216,65	210,15	201,51	
	5	Q _o	861984	726678	605370	496394	398085	308777		
		P _e	259,65	256,58	252,68	247,48	240,48	231,22		
	CXH92-300-912Y	30	Q _o	1171766	1000509	850025	717950	601921	499574	408546
			P _e	168,33	159,87	153,75	149,54	146,79	145,08	143,97
		40	Q _o	1093871	934303	793315	668545	557628	458200	367900
			P _e	201,77	196,53	192,77	190,05	187,95	186,02	183,83
50		Q _o	1004899	856333	724156	606003	499512	402318	312058	
		P _e	251,70	248,47	245,86	243,45	240,78	237,43	232,97	
55		Q _o	953426	810104	682075	566973	462437	366102		
		P _e	283,35	280,67	278,19	275,47	272,08	267,57		

⑧ Per dati di prestazione in punti operativi diversi vedi Frascold Selection Software.

⑧ Performance data for individual conditions see Frascold Selection Software.

⑧ Leistungsdaten für individuelle Betriebsbedingungen siehe Frascold Selection Software.

Con raffreddatore d'olio
Con raffreddatore d'olio o iniezione di liquido

With oil cooler
With oil cooler or liquid injection

Mit Ölkühler
Mit Ölkühler oder Flüssigkeitseinspritzung

R22 • 50 Hz

Senza economizzatore Without economiser Ohne Economizer

Dati riferiti con surriscaldamento 10 K, senza sottoraffreddamento del liquido

Data referred to 10 K superheat, without liquid subcooling

Bezogen auf 10 K Sauggas-Überhitzung, ohne Flüssigkeits-Unterkuhlung

Prestazioni Performance Leistungswerte

Compressore Compressor Verdichter	Condensazione Condensing Verflüssigungs- temperatur °C	Q _o (Watt) P _e (kW) 50 Hz	Potenza frigorifera ⑧ Potenza assorbita ⑨		Cooling capacity ⑧ Power consumption ⑨		Kälteleistung ⑧ Leistungsaufnahme ⑨		
			Temperatura di evaporazione °C		Evaporating temperature °C		Verdampfungstemperatur °C		
			10	5	0	-5	-10	-15	-20
CXH02-70-199Y	30	Q _o	215427	184374	153533	124832	100201	81569	
		P _e	38,56	36,64	34,99	33,63	32,55	31,75	
	40	Q _o	226525	195353	163604	133209	106095	84192	69428
		P _e	46,78	44,96	43,28	41,77	40,43	39,25	38,25
	50	Q _o	197963	167185	136972	109253	85956	69011	60347
		P _e	55,32	53,55	51,82	50,73	48,49	46,91	45,38
55	Q _o	181202	151458	122849	97305	76753	63124		
	P _e	60,38	58,52	56,64	54,75	52,85	50,95		
CXH02-80-230Y	30	Q _o	248007	212664	177728	145367	117746	97034	
		P _e	45,13	42,95	40,93	39,14	37,62	36,43	
	40	Q _o	260033	225342	189912	155909	125502	100855	84137
		P _e	55,27	53,25	51,25	49,34	47,56	45,98	44,64
	50	Q _o	229632	195613	161875	130586	103912	84019	73076
		P _e	65,84	63,84	61,78	59,71	57,69	55,78	54,04
55	Q _o	212428	179412	147188	117922	93782	76934		
	P _e	71,71	69,62	67,43	65,19	62,96	60,79		
CXH02-90-264Y	30	Q _o	281770	242729	204222	168297	137004	112391	
		P _e	50,16	48,42	46,74	45,13	43,59	42,12	
	40	Q _o	298772	260121	220794	182842	148313	119255	97717
		P _e	61,34	59,92	58,39	56,75	55,02	53,19	51,27
	50	Q _o	267933	229699	191631	155778	124188	98909	81991
		P _e	74,33	72,75	70,89	68,77	66,37	63,72	60,81
55	Q _o	249475	212030	175170	140945	111403	88593		
	P _e	81,71	79,85	77,63	75,06	72,14	68,87		
CXH02-100-298Y	30	Q _o	318066	273996	230528	189976	154651	126868	
		P _e	56,62	54,66	52,76	50,95	49,21	47,55	
	40	Q _o	337258	293627	249235	206394	167417	134616	110305
		P _e	69,25	67,64	65,91	64,07	62,11	60,04	57,87
	50	Q _o	302445	259287	216316	175844	140184	111650	92554
		P _e	83,90	82,12	80,02	77,62	74,93	71,93	68,64
55	Q _o	281611	239342	197734	159101	125754	100006		
	P _e	92,23	90,13	87,63	84,73	81,43	77,75		
CXH52-110-316Y	30	Q _o	352293	301540	251121	204183	163875	133343	
		P _e	60,32	57,31	54,74	52,61	50,93	49,69	
	40	Q _o	370389	319439	267546	217859	173524	137689	113501
		P _e	73,14	70,27	67,66	65,31	63,23	61,41	59,86
	50	Q _o	323768	273428	224016	178681	140569	112828	98605
		P _e	86,49	83,70	81,00	78,38	75,85	73,41	71,05
55	Q _o	296393	247716	200903	159102	125459	103122		
	P _e	94,43	91,50	88,56	85,62	82,68	79,73		
CXH02-120-340Y	30	Q _o	379090	324477	270222	219714	176340	143485	
		P _e	64,91	61,67	58,90	56,61	54,80	53,47	
	40	Q _o	398562	343737	287897	234430	186723	148161	122133
		P _e	78,70	75,61	72,80	70,28	68,04	66,08	64,42
	50	Q _o	348395	294226	241056	192272	151261	121409	106104
		P _e	93,07	90,07	87,16	84,34	81,62	78,99	76,45
55	Q _o	318938	266559	216185	171203	135001	110965		
	P _e	101,61	98,46	95,30	92,13	88,97	85,80		
CXH52-125-372Y	30	Q _o	411588	353504	296199	242706	196059	159292	
		P _e	71,74	68,31	65,22	62,46	60,01	57,86	
	40	Q _o	432326	374907	316612	260475	209529	166809	135349
		P _e	87,94	84,75	81,68	78,74	75,88	73,11	70,39
	50	Q _o	383003	326457	270415	217910	171977	135649	111960
		P _e	104,85	101,73	98,51	95,16	91,68	88,04	84,23
55	Q _o	354502	299317	245325	195561	153058	120850		
	P _e	114,24	110,96	107,45	103,71	99,71	95,44		
CXH52-140-428Y	30	Q _o	470542	405159	340728	280757	228754	188226	
		P _e	80,09	77,28	74,57	72,00	69,60	67,41	
	40	Q _o	498767	434350	368713	305366	247814	199565	164127
		P _e	97,93	95,69	93,24	90,62	87,88	85,04	82,16
	50	Q _o	447697	383892	320204	260140	207207	164914	136767
		P _e	118,78	116,23	113,22	109,77	105,93	101,74	97,23
55	Q _o	416910	354237	292348	234751	184954	146463		
	P _e	130,56	127,52	123,87	119,67	114,93	109,71		

⑧ Vedi nota a pagina 17

⑨ See notes on page 17

⑩ Siehe Notes auf Seite 17

R22 • 50 Hz

Senza economizzatore Without economiser Ohne Economizer

**Prestazioni
Performance
Leistungswerte**

Dati riferiti con surriscaldamento 10 K, senza sottoraffreddamento del liquido
Data referred to 10 K superheat, without liquid subcooling
Bezogen auf 10 K Sauggas-Überhitzung, ohne Flüssigkeits-Unterkühlung

Compressore Compressor Verdichter	Condensazione Condensing Verflüssigungs- temperatur °C	Q _o (Watt) P _e (kW) 50 Hz	Potenza frigorifera ⑧ Potenza assorbita ⑧			Cooling capacity ⑧ Power consumption ⑧			Kälteleistung ⑧ Leistungsaufnahme ⑧	
			Temperatura di evaporazione °C			Evaporating temperature °C			Verdampfungstemperatur °C	
			10	5	0	-5	-10	-15	-20	
CXH52-160-468Y	30	Q _o		513783	441399	371342	306680	250480	205811	
		P _e		87,58	84,50	81,54	78,73	76,10	73,71	
	40	Q _o	546802	474580	402555	333794	271367	218340	177782	
		P _e	107,09	104,63	101,96	99,10	96,10	93,00	89,84	
	50	Q _o	489628	419337	350181	285227	227545	180201	146264	
		P _e	129,88	127,10	123,80	120,04	115,84	111,25	106,32	
	55	Q _o	455005	386620	319840	257731	203363	159802		
		P _e	142,76	139,44	135,45	130,85	125,68	119,97		
	CXH92-180-545Y	30	Q _o		613979	525595	437802	356082	285915	232781
			P _e		103,17	98,09	93,74	90,10	87,17	84,94
		40	Q _o	645711	556962	466585	380061	302871	240495	198414
			P _e	125,22	120,35	115,91	111,87	108,24	105,00	102,15
50		Q _o	564793	477093	391026	312074	245716	197435	172710	
		P _e	148,11	143,35	138,70	134,14	129,67	125,29	120,98	
55		Q _o	517281	432469	350921	278118	219541	180670		
		P _e	161,66	156,63	151,56	146,42	141,22	135,95		
CXH92-210-620Y		30	Q _o		693325	595010	498222	408359	330819	271000
			P _e		118,65	112,91	107,74	103,21	99,38	96,34
		40	Q _o	727984	631727	533644	439133	353592	282419	231014
			P _e	145,38	140,29	135,25	130,33	125,61	121,13	116,99
	50	Q _o	646190	551224	456477	367348	289234	227535	187648	
		P _e	173,63	168,55	163,08	157,28	151,22	144,97	138,59	
	55	Q _o	598481	505325	413410	328136	254901	199103		
		P _e	189,13	183,64	177,53	170,86	163,71	156,14		
	CXH92-240-702Y	30	Q _o		779990	671646	564884	465516	379352	312202
			P _e		130,23	125,75	121,42	117,28	113,35	109,65
		40	Q _o	826905	720132	611361	506402	411067	331165	272508
			P _e	159,45	155,82	151,87	147,62	143,12	138,39	133,45
50		Q _o	742520	636744	531199	431697	344047	274062	227551	
		P _e	193,35	189,23	184,36	178,74	172,43	165,44	157,80	
55		Q _o	691655	587747	485186	389781	307345	243687		
		P _e	212,40	207,50	201,61	194,77	187,01	178,34		
CXH92-280-810Y		30	Q _o		867469	747879	629756	519607	423936	349250
			P _e		149,74	143,84	138,36	133,63	129,95	127,63
		40	Q _o	923824	803968	681892	564103	457107	367408	301512
			P _e	179,77	176,78	172,80	168,14	163,09	157,98	153,11
	50	Q _o	836039	714444	593448	479558	379280	299118	245578	
		P _e	218,36	214,81	209,15	201,68	192,72	182,57	171,53	
	55	Q _o	781966	660838	541720	431117	335534	261478		
		P _e	239,97	234,79	226,93	216,71	204,43	190,41		
	CXH92-300-912Y	30	Q _o		970446	837099	705551	582476	474551	388448
			P _e		165,26	159,50	153,97	148,79	144,07	139,93
		40	Q _o	1033556	900152	765056	634941	516484	416359	341240
			P _e	200,67	197,13	192,87	188,01	182,66	176,93	170,94
50		Q _o	938496	804557	672109	547827	438385	350459	290722	
		P _e	244,50	240,68	235,31	228,49	220,34	210,98	200,52	
55		Q _o	880971	748415	618941	499224	395939	315761		
		P _e	269,08	264,14	257,22	248,44	237,92	225,76		

⑧ Per dati di prestazione in punti operativi diversi vedi Frascold Selection Software.

⑧ Performance data for individual conditions see Frascold Selection Software.

⑧ Leistungsdaten für individuelle Betriebsbedingungen siehe Frascold Selection Software.

Con raffreddatore d'olio
Con raffreddatore d'olio o iniezione di liquido

With oil cooler
With oil cooler or liquid injection

Mit Ölkühler
Mit Ölkühler oder Flüssigkeitseinspritzung

R22 • 50 Hz

Con economizzatore With economiser Mit Economizer

Dati riferiti con surriscaldamento 10 K, con sottoraffreddamento del liquido

Data referred to 10 K superheat, with liquid subcooling

Bezogen auf 10 K Sauggas-Überhitzung, mit Flüssigkeits-Unterkuhlung

Prestazioni

Performance

Leistungswerte

Compressore Compressor Verdichter	Condensazione Condensing Verflüssigungs- temperatur °C	Q _o (Watt) P _e (kW) 50 Hz ↓	Potenza frigorifera ⑧ Potenza assorbita ⑨		Cooling capacity ⑧ Power consumption ⑨		Kälteleistung ⑧ Leistungsaufnahme ⑨		
			Temperatura di evaporazione °C		Evaporating temperature °C		Verdampfungstemperatur °C		
			10	5	0	-5	-10	-15	-20
CXH02-70-199Y	30	Q _o		227046	198482	169318	141406	116597	96741
		P _e		39,65	38,38	37,46	36,77	36,22	35,70
	40	Q _o	245366	215961	185256	155102	127349	103850	86455
		P _e	49,17	48,20	47,42	46,74	46,03	45,20	44,13
	50	Q _o	226025	195495	164815	135835	110409	90386	77617
		P _e	61,05	60,29	59,47	58,49	57,22	55,57	53,42
55	Q _o	213330	183050	153194	125615	102164	84691		
	P _e	68,37	67,52	66,48	65,14	63,39	61,13		
CXH02-80-230Y	30	Q _o		256853	224649	192767	162474	135039	111729
		P _e		45,89	44,51	43,43	42,51	41,60	40,56
	40	Q _o	277394	244138	210695	178332	148318	121921	100408
		P _e	57,49	56,54	55,78	55,06	54,23	53,15	51,68
	50	Q _o	256424	223122	190392	159501	131718	108312	90549
		P _e	72,06	71,63	71,12	70,39	69,29	67,68	65,40
55	Q _o	243268	210675	179034	149612	123677	102498		
	P _e	80,83	80,52	80,00	79,13	77,75	75,73		
CXH02-90-264Y	30	Q _o		287549	251168	215870	183018	153975	130102
		P _e		50,73	49,04	47,98	47,27	46,62	45,75
	40	Q _o	310785	274948	238841	203827	171267	142525	118961
		P _e	62,34	61,37	60,84	60,45	59,91	58,96	57,29
	50	Q _o	291028	255414	219539	184765	152455	123969	100671
		P _e	77,56	77,25	76,89	76,18	74,84	72,59	69,13
55	Q _o	278243	242725	206949	172279	140077	111704		
	P _e	86,91	86,56	85,91	84,67	82,56	79,29		
CXH02-100-298Y	30	Q _o		324589	283521	243676	206593	173808	146860
		P _e		57,27	55,36	54,16	53,36	52,63	51,65
	40	Q _o	350818	310364	269607	230082	193328	160883	134283
		P _e	70,37	69,28	68,67	68,23	67,63	66,55	64,67
	50	Q _o	328516	288315	247818	208565	172092	139937	113638
		P _e	87,55	87,20	86,79	85,99	84,48	81,94	78,04
55	Q _o	314085	273991	233607	194470	158120	126092		
	P _e	98,10	97,71	96,98	95,58	93,20	89,50		
CXH52-110-316Y	30	Q _o		370787	324334	276938	231498	190918	158097
		P _e		62,06	60,11	58,71	57,67	56,78	55,86
	40	Q _o	401890	353645	303482	254303	209010	170502	141682
		P _e	77,06	75,58	74,44	73,45	72,39	71,09	69,33
	50	Q _o	371514	321015	270528	222952	181188	148139	126706
		P _e	95,82	94,70	93,50	92,03	90,09	87,48	84,01
55	Q _o	350888	300533	251152	205647	166918	137868		
	P _e	107,33	106,05	104,49	102,45	99,74	96,16		
CXH02-120-340Y	30	Q _o		398990	349004	298002	249107	205440	170122
		P _e		66,78	64,68	63,17	62,05	61,10	60,11
	40	Q _o	432459	380544	326566	273647	224908	183471	152460
		P _e	82,92	81,33	80,11	79,03	77,90	76,50	74,60
	50	Q _o	399772	345433	291105	239910	194970	159407	136343
		P _e	103,11	101,90	100,61	99,03	96,94	94,14	90,40
55	Q _o	377578	323393	270256	221289	179614	148354		
	P _e	115,49	114,11	112,43	110,24	107,33	103,47		
CXH52-125-372Y	30	Q _o		428015	375545	322037	270702	224752	187397
		P _e		73,00	70,67	68,81	67,24	65,81	64,33
	40	Q _o	462257	408675	352851	297996	247321	204037	171356
		P _e	91,36	89,64	88,17	86,80	85,35	83,67	81,57
	50	Q _o	430368	374654	318704	265731	218944	181556	156778
		P _e	113,52	112,38	111,12	109,59	107,62	105,03	101,67
55	Q _o	409104	353535	298733	247911	204280	171051		
	P _e	126,33	125,23	123,84	121,99	119,51	116,23		
CXH52-140-428Y	30	Q _o		479509	418848	360151	305590	257336	217561
		P _e		81,03	78,26	76,53	75,41	74,45	73,18
	40	Q _o	518756	458805	398634	340414	286318	238518	199185
		P _e	99,53	97,98	97,13	96,52	95,71	94,24	91,66
	50	Q _o	487643	427735	367596	309397	255310	207506	168158
		P _e	123,95	123,51	122,96	121,84	119,71	116,11	110,59
55	Q _o	467694	407637	347342	288982	234727	186751		
	P _e	139,01	138,52	137,51	135,53	132,13	126,85		

⑧ Vedi nota a pagina 19

⑨ See notes on page 19

⑩ Siehe Notes auf Seite 19

R22 • 50 Hz

Con economizzatore With economiser Mit Economizer

Prestazioni Performance Leistungswerte

Dati riferiti con surriscaldamento 10 K, con sottoraffreddamento del liquido

Data referred to 10 K superheat, with liquid subcooling

Bezogen auf 10 K Sauggas-Überhitzung, mit Flüssigkeits-Unterkühlung

Compressore Compressor Verdichter	Condensazione Condensing Verflüssigungs- temperatur °C	Q _o (Watt) P _e (kW) 50 Hz ↓	Potenza frigorifera ⑧ Potenza assorbita ⑧		Cooling capacity ⑧ Power consumption ⑧			Kälteleistung ⑧ Leistungsaufnahme ⑧		
			Temperatura di evaporazione °C		Evaporating temperature °C			Verdampfungstemperatur °C		
			10	5	0	-5	-10	-15	-20	
CXH52-160-468Y	30	Q _o		524830	458379	393983	334098	281177	237673	
		P _e		88,61	85,57	83,69	82,47	81,41	80,02	
	40	Q _o	567293	502073	436361	372613	313281	260821	217685	
		P _e	108,84	107,14	106,21	105,55	104,66	103,05	100,23	
	50	Q _o	532238	467467	402113	338629	279468	227085	183934	
		P _e	135,54	135,06	134,45	133,23	130,90	126,97	120,93	
	55	Q _o	509609	444920	379601	316105	256887	204399		
		P _e	152,01	151,47	150,36	148,20	144,48	138,71		
	CXH92-180-545Y	30	Q _o		645828	564364	481386	402108	331746	275515
			P _e		106,06	102,68	100,21	98,35	96,80	95,25
		40	Q _o	697064	613503	526400	440968	362425	295985	246863
			P _e	131,39	128,68	126,55	124,69	122,79	120,56	117,69
50		Q _o	641610	554916	467866	385676	313561	256737	220418	
		P _e	162,29	160,13	157,91	155,31	152,03	147,78	142,24	
55		Q _o	604962	518836	433948	355514	288749	238867		
		P _e	181,12	178,73	175,95	172,48	168,01	162,24		
CXH92-210-620Y		30	Q _o		720526	631453	540857	454280	377264	315352
			P _e		120,87	116,99	113,79	111,09	108,70	106,43
		40	Q _o	775369	685146	591134	498877	413915	341792	288049
			P _e	150,65	147,63	144,98	142,49	139,99	137,28	134,18
	50	Q _o	719416	626008	532089	443201	364886	302687	262146	
		P _e	186,23	183,95	181,51	178,73	175,42	171,39	166,46	
	55	Q _o	683118	590005	498019	412703	339599	284248		
		P _e	206,92	204,63	201,93	198,62	194,53	189,46		
	CXH92-240-702Y	30	Q _o		795599	694658	596818	505845	425502	359551
			P _e		131,79	127,47	124,70	122,80	121,05	118,77
		40	Q _o	859341	759951	659945	563089	473144	393876	329048
			P _e	162,06	159,51	158,00	156,85	155,35	152,82	148,54
50		Q _o	803924	705297	606102	510102	421061	342743	278911	
		P _e	201,28	200,20	198,96	196,88	193,24	187,36	178,54	
55		Q _o	768163	669871	571034	475415	386778	308888		
		P _e	225,04	223,74	221,69	218,18	212,52	204,02		
CXH92-280-810Y		30	Q _o		897507	788717	678117	572208	477493	400474
			P _e		151,99	148,29	145,19	142,57	140,30	138,26
		40	Q _o	977534	864349	747206	632604	527046	437034	369070
			P _e	185,77	185,03	183,83	182,03	179,51	176,15	171,82
	50	Q _o	919513	799503	679885	567161	467833	388403	335372	
		P _e	232,20	231,93	230,00	226,28	220,64	212,96	203,11	
	55	Q _o	878011	756792	638141	528561	434552	362618		
		P _e	259,17	257,93	254,42	248,53	240,12	229,08		
	CXH92-300-912Y	30	Q _o		988030	863181	741961	628773	528017	444095
			P _e		166,31	161,64	157,94	154,93	152,36	149,97
		40	Q _o	1070436	944877	819546	698846	587178	488943	408543
			P _e	203,74	202,06	200,37	198,42	195,94	192,68	188,37
50		Q _o	1007587	881027	755698	635999	526333	431102	354707	
		P _e	252,85	252,63	251,18	248,25	243,56	236,87	227,90	
55		Q _o	966736	839858	714709	595693	487209	393660		
		P _e	281,24	280,73	278,37	273,91	267,10	257,66		

⑧ Per dati di prestazione in punti operativi diversi vedi Frascold Selection Software.

⑧ Performance data for individual conditions see Frascold Selection Software.

⑧ Leistungsdaten für individuelle Betriebsbedingungen siehe Frascold Selection Software.

Con raffreddatore d'olio

With oil cooler

Mit Ölkühler

Con raffreddatore d'olio o iniezione di liquido

With oil cooler or liquid injection

Mit Ölkühler oder Flüssigkeitseinspritzung

R134a • 60 Hz

Senza economizzatore Without economiser Ohne Economizer

Prestazioni
Performance
Leistungswerte

Dati riferiti con surriscaldamento 10 K, senza sottoraffreddamento del liquido

Data referred to 10 K superheat, without liquid subcooling

Bezogen auf 10 K Sauggas-Überhitzung, ohne Flüssigkeits-Unter Kühlung

Compressore Compressor Verdichter	Condensazione Condensing Verflüssigungs- temperatur °C	Q _o (Watt) P _e (kW) 60 Hz ↓	Potenza frigorifera Ⓢ Ⓣ Potenza assorbita Ⓢ Ⓣ		Cooling capacity Ⓢ Ⓣ Power consumption Ⓢ Ⓣ		Kälteleistung Ⓢ Ⓣ Leistungsaufnahme Ⓢ Ⓣ	
			Temperatura di evaporazione °C		Evaporating temperature °C		Verdampfungstemperatur °C	
			10	5	0	-5	-10	-15
CXH01-50-199Y	30	Q _o	177396	144972	117199	93582	73625	
		P _e	30,65	30,03	29,12	28,11	27,23	
	40	Q _o	191375	156694	126807	101218	79431	60951
		P _e	37,73	36,62	35,28	33,93	32,76	31,99
	50	Q _o	163972	132741	105950	83104	63707	47264
		P _e	44,43	42,81	41,24	39,94	39,10	38,93
60	Q _o	133698	106476	83341	63798	47351		
	P _e	52,82	51,19	49,89	49,12	49,10		
CXH01-60-230Y	30	Q _o	207484	170133	138075	110733	87528	
		P _e	33,67	32,61	31,70	30,93	30,31	
	40	Q _o	224637	184905	150565	121039	95749	74116
		P _e	41,58	40,15	38,86	37,72	36,71	35,83
	50	Q _o	195286	159277	128180	101417	78410	58581
		P _e	49,74	48,21	46,81	45,55	44,42	43,41
60	Q _o	162607	130552	102929	79161	58669		
	P _e	60,34	58,82	57,43	56,16	55,02		
CXH01-70-264Y	30	Q _o	232847	190911	155050	124623	98991	
		P _e	38,75	36,98	35,49	34,32	33,53	
	40	Q _o	252338	207800	169426	136576	108610	84890
		P _e	48,65	46,27	44,18	42,44	41,09	40,18
	50	Q _o	220291	180182	145687	116166	90979	69488
		P _e	57,62	55,20	53,13	51,48	50,29	49,62
60	Q _o	185961	150598	120300	94425	72335		
	P _e	70,04	67,91	66,20	64,99	64,30		
CXH01-80-298Y	30	Q _o	268347	219951	178589	143506	113947	
		P _e	45,49	42,65	40,70	39,33	38,20	
	40	Q _o	291028	239084	194467	156422	124192	97023
		P _e	56,29	53,17	50,97	49,37	48,04	46,65
	50	Q _o	254415	206831	166111	131499	102240	77579
		P _e	66,76	64,08	62,02	60,27	58,49	56,35
60	Q _o	214055	170949	134243	103183	77012		
	P _e	80,28	77,55	75,15	72,74	70,01		
CXH01-90-340Y	30	Q _o	292877	240752	196279	158635	126993	
		P _e	50,40	48,05	46,27	44,93	43,88	
	40	Q _o	319844	263573	215267	174102	139253	109893
		P _e	61,45	59,23	57,42	55,89	54,52	53,16
	50	Q _o	282527	230795	186516	148865	117017	90147
		P _e	74,14	72,09	70,17	68,25	66,20	63,90
60	Q _o	240968	193981	153935	120005	91366		
	P _e	91,19	88,66	85,99	83,03	79,66		
CXH01-100-370Y	30	Q _o	318724	261998	213601	172634	138200	
		P _e	54,84	52,29	50,36	48,89	47,75	
	40	Q _o	348070	286833	234264	189467	151541	119591
		P _e	66,87	64,45	62,49	60,83	59,33	57,86
	50	Q _o	307460	251162	202975	162002	127344	98103
		P _e	80,69	78,45	76,37	74,28	72,05	69,53
60	Q _o	262234	211100	167520	130595	99429		
	P _e	99,24	96,49	93,57	90,36	86,69		
CXH51-110-398Y	30	Q _o	369503	303106	246552	198818	158880	
		P _e	57,73	55,89	54,19	52,58	51,00	
	40	Q _o	402951	332067	271214	219370	175510	138612
		P _e	71,81	69,70	67,78	66,02	64,34	62,70
	50	Q _o	354081	290061	235237	188587	149086	115712
		P _e	86,23	84,07	82,11	80,30	78,58	76,91
60	Q _o	299999	243327	195017	154045	119388		
	P _e	104,22	102,03	100,06	98,25	96,53		
CXH51-125-468Y	30	Q _o	423079	348078	283754	228930	182426	
		P _e	70,83	66,28	62,83	60,26	58,34	
	40	Q _o	461472	380147	310087	250114	199050	155716
		P _e	85,82	81,10	77,29	74,18	71,52	69,11
	50	Q _o	406270	331203	266812	211917	165340	125902
		P _e	99,85	95,82	92,31	89,07	85,88	82,50
60	Q _o	345534	277454	219457	170367	129003		
	P _e	119,13	115,36	111,67	107,85	103,67		

Ⓢ Ⓣ Vedi nota a pagina 21

Ⓢ Ⓣ See notes on page 21

Ⓢ Ⓣ Siehe Notes auf Seite 21













R134a • 60 Hz

Senza economizzatore Without economiser Ohne Economizer
**Prestazioni
Performance
Leistungswerte**

Dati riferiti con surriscaldamento 10 K, senza sottoraffreddamento del liquido

Data referred to 10 K superheat, without liquid subcooling

Bezogen auf 10 K Sauggas-Überhitzung, ohne Flüssigkeits-Unterkühlung

Compressore Compressor Verdichter	Condensazione Condensing Verflüssigungs- temperatur °C	Q_o (Watt) P_e (kW) 60 Hz	Potenza frigorifera   Potenza assorbita  		Cooling capacity   Power consumption  		Kälteleistung   Leistungsaufnahme  	
			Temperatura di evaporazione °C		Evaporating temperature °C		Verdampfungstemperatur °C	
			10	5	0	-5	-10	-15
CXH51-140-538Y	30	Q _o	482104	396651	323532	261428	209021	
		P _e	78,34	75,31	72,45	69,80	67,40	
	40	Q _o	525049	433461	354694	287430	230350	182136
		P _e	95,78	92,38	89,26	86,46	84,02	81,99
	50	Q _o	464784	381058	309323	248261	196551	152876
		P _e	115,01	111,23	107,88	105,00	102,64	100,84
	60	Q _o	400613	325096	260739	206223	160230	
		P _e	140,36	136,05	132,33	129,23	126,80	
CXH91-160-620Y	30	Q _o	564776	463957	377170	302777	239135	
		P _e	89,15	86,44	84,03	81,98	80,30	
	40	Q _o	615767	507207	413416	332752	263576	204246
		P _e	109,75	106,14	102,80	99,76	97,07	94,75
	50	Q _o	539891	440654	355279	282127	219556	165926
		P _e	130,81	126,90	123,26	119,92	116,91	114,27
	60	Q _o	455154	366627	291058	226804	172227	
		P _e	157,49	153,62	150,00	146,68	143,68	
CXH91-180-702Y	30	Q _o	645579	533218	436508	353614	282698	
		P _e	99,67	96,63	94,04	91,50	88,60	
	40	Q _o	704671	583177	478220	387963	310570	244205
		P _e	122,80	120,20	118,07	116,01	113,61	110,47
	50	Q _o	623790	512210	416216	333971	263639	203385
		P _e	149,64	147,37	145,17	142,66	139,43	135,06
	60	Q _o	535196	435091	349620	276947	215237	
		P _e	183,94	181,01	177,78	173,84	168,79	
CXH91-210-810Y	30	Q _o	728815	599544	488925	394937	315563	
		P _e	116,30	112,46	109,13	106,13	103,30	
	40	Q _o	796868	657476	537588	435184	348245	274754
		P _e	146,03	140,66	136,00	131,87	128,09	124,50
	50	Q _o	706357	578363	468705	375366	296325	229565
		P _e	174,32	168,33	163,06	158,35	154,01	149,89
	60	Q _o	608092	492344	393766	310340	240046	
		P _e	208,77	202,37	196,71	191,64	186,96	
CXH91-240-912Y	30	Q _o	796697	654688	533171	429953	342843	
		P _e	125,97	122,71	119,11	115,45	112,00	
	40	Q _o	871040	718365	586987	474714	379355	298718
		P _e	158,08	153,10	148,14	143,48	139,38	136,11
	50	Q _o	772695	633287	513789	412010	325759	252845
		P _e	190,76	184,28	178,45	173,54	169,82	167,56
	60	Q _o	667131	542239	435872	345837	269945	
		P _e	228,96	221,79	215,90	211,56	209,03	

 Per dati di prestazione in punti operativi diversi vedi Frascold Selection Software.

 Sono riportati solo i dati dei modelli con motore taglia 1. Per i dati di prestazione dei modelli con motore taglia 2 vedi Frascold Selection Software.

 Performance data for individual conditions see Frascold Selection Software.

 Data referred to models with motor size 1. For data of the models with motor size 2 see Frascold Selection Software.

 Leistungsdaten für individuelle Betriebsbedingungen siehe Frascold Selection Software.

 Daten gelten für Verdichter mit Motor Version 1. Für Verdichter mit Motor Version 2 siehe Frascold Selection Software.

 Con raffreddatore d'olio

 With oil cooler

 Mit Ölkühler













R134a • 60 Hz

Con economizzatore With economiser Mit Economizer
**Prestazioni
Performance
Leistungswerte**

Dati riferiti con surriscaldamento 10 K, con sottoraffreddamento del liquido

Data referred to 10 K superheat, with liquid subcooling

Bezogen auf 10 K Sauggas-Überhitzung, mit Flüssigkeits-Unter Kühlung

Compressore Compressor Verdichter	Condensazione Condensing Verflüssigungs- temperatur °C	Q_o (Watt) P_e (kW) 60 Hz 	Potenza frigorifera   Potenza assorbita  		Cooling capacity   Power consumption  		Kälteleistung   Leistungsaufnahme  	
			Temperatura di evaporazione °C		Evaporating temperature °C		Verdampfungstemperatur °C	
			10	5	0	-5	-10	-15
CXH01-50-199Y	30	Q _o	188161	158104	131625	108378	88016	
		P _e	31,68	31,54	31,74	30,64	30,19	
	40	Q _o	208606	175871	146836	121155	98482	78470
		P _e	39,65	39,29	38,67	37,94	37,26	36,77
	50	Q _o	190017	159049	131558	107196	85619	66479
		P _e	48,94	48,24	47,42	46,65	46,06	45,80
60	Q _o							
	P _e							
CXH01-60-230Y	30	Q _o	217106	182817	152672	126201	102932	
		P _e	34,63	34,05	33,74	33,62	33,62	
	40	Q _o	240793	203753	170954	141926	116197	93297
		P _e	43,40	42,90	42,54	42,23	41,91	41,50
	50	Q _o	220915	185984	154920	127253	102512	80226
		P _e	54,66	54,45	54,16	53,73	53,07	52,12
60	Q _o	195887	163310	134227	108167	84658		
	P _e	70,39	70,34	70,00	69,30	68,17		
CXH01-70-264Y	30	Q _o	237269	200316	167765	139179	114124	
		P _e	38,99	37,79	36,96	36,41	36,09	
	40	Q _o	263650	223622	188142	156775	129086	104640
		P _e	49,44	47,78	46,55	45,68	45,10	44,74
	50	Q _o	243230	205508	172046	142410	116163	92872
		P _e	60,58	59,11	58,07	57,39	56,99	56,82
60	Q _o	218261	183391	152492	125132	100874		
	P _e	76,61	75,56	74,94	74,67	74,70		
CXH01-80-298Y	30	Q _o	279510	234560	195404	161423	131999	
		P _e	46,46	44,15	42,88	42,24	41,78	
	40	Q _o	309309	260475	217714	180406	147934	119678
		P _e	58,37	56,24	55,07	54,44	53,92	53,08
	50	Q _o	283353	237127	196634	161254	130369	103361
		P _e	72,28	71,09	70,37	69,66	68,56	66,63
60	Q _o	251672	208134	169987	136615	107397		
	P _e	91,21	90,27	89,27	87,79	85,40		
CXH01-90-340Y	30	Q _o	298026	251422	210691	175231	144442	
		P _e	50,64	48,83	47,72	47,10	46,79	
	40	Q _o	332542	281338	236373	197045	162755	132901
		P _e	62,40	60,99	60,07	59,44	58,91	58,27
	50	Q _o	308179	259215	216256	178701	145949	117400
		P _e	77,28	76,43	75,66	74,78	73,58	71,87
60	Q _o	276755	230401	189817	154404	123559		
	P _e	97,80	96,77	95,41	93,53	90,93		
CXH01-100-370Y	30	Q _o	324326	273611	229285	190696	157188	
		P _e	55,11	53,14	51,93	51,26	50,91	
	40	Q _o	361889	306166	257233	214435	177118	144629
		P _e	67,91	66,37	65,37	64,69	64,11	63,41
	50	Q _o	335376	282091	235341	194472	158830	127760
		P _e	84,10	83,17	82,34	81,38	80,08	78,21
60	Q _o	301178	250733	206568	168030	134464		
	P _e	106,43	105,31	103,83	101,78	98,95		
CXH51-110-398Y	30	Q _o	375966	317571	266304	221513	182545	
		P _e	58,07	56,99	56,19	55,48	54,68	
	40	Q _o	420574	357071	300957	251577	208280	170413
		P _e	73,10	72,15	71,50	70,97	70,39	69,58
	50	Q _o	390959	330955	277946	231278	190300	154359
		P _e	90,75	90,27	89,94	89,60	89,05	88,12
60	Q _o	352286	296606	247527	204396	166562		
	P _e	113,80	113,70	113,60	113,34	112,72		
CXH51-125-468Y	30	Q _o	440947	371903	311392	258478	212227	
		P _e	72,23	68,50	66,02	64,47	63,53	
	40	Q _o	491538	415542	348648	289922	238427	193228
		P _e	88,73	85,31	82,82	80,93	79,34	77,73
	50	Q _o	454732	382000	318005	261811	212482	169082
		P _e	106,71	104,53	102,64	100,73	98,47	95,56
60	Q _o	409817	341098	280748	227833	181417		
	P _e	131,90	130,34	128,43	125,86	122,31		

  Vedi nota a pagina 23

  See notes on page 23

  Siehe Notes auf Seite 23

R134a • 60 Hz

Con economizzatore With economiser Mit Economizer

Prestazioni Performance Leistungswerte

Data riferiti con surriscaldamento 10 K, con sottoraffreddamento del liquido

Data referred to 10 K superheat, with liquid subcooling

Bezogen auf 10 K Sauggas-Überhitzung, mit Flüssigkeits-Unterkühlung

Compressore Compressor Verdichter	Condensazione Condensing Verflüssigungs- temperatur °C	Q _o (Watt) P _e (kW) 60 Hz ↓	Potenza frigorifera ⑧ ⑨ Potenza assorbita ⑧ ⑨		Cooling capacity ⑧ ⑨ Power consumption ⑧ ⑨		Kälteleistung ⑧ ⑨ Leistungsaufnahme ⑧ ⑨	
			Temperatura di evaporazione °C		Evaporating temperature °C		Verdampfungstemperatur °C	
			10	5	0	-5	-10	-15
CXH51-140-538Y	30	Q _o	490161	413930	347079	288669	237763	
		P _e	78,93	76,68	74,75	73,11	71,69	
	40	Q _o	545609	462624	389558	325472	269428	220489
		P _e	97,13	94,98	93,20	91,77	90,62	89,71
	50	Q _o	507513	428695	359396	298678	245604	199235
		P _e	119,70	117,65	115,99	114,68	113,66	112,89
	60	Q _o	462005	387956	323028	266281	216780	
		P _e	150,51	148,20	146,30	144,76	143,52	
CXH91-160-620Y	30	Q _o	590486	498104	416581	344585	280785	
		P _e	91,25	89,92	89,07	88,50	88,03	
	40	Q _o	659096	557917	468401	389215	319026	256502
		P _e	113,95	112,29	111,02	109,96	108,92	107,73
	50	Q _o	608794	512654	427646	352440	285701	226097
		P _e	141,07	139,70	138,45	137,15	135,62	133,67
	60	Q _o	545014	455556	376701	307117	245470	
		P _e	177,05	175,93	174,68	173,12	171,06	
CXH91-180-702Y	30	Q _o	657117	558858	471568	393972	324799	
		P _e	100,39	98,63	97,58	96,65	95,28	
	40	Q _o	735353	626376	529524	443522	367098	298978
		P _e	125,04	124,34	124,29	124,31	123,84	122,28
	50	Q _o	686076	581230	488390	406284	333638	269178
		P _e	156,98	157,40	157,84	157,72	156,47	153,51
	60	Q _o	623044	524935	438716	363112	296851	
		P _e	199,39	199,71	199,43	197,95	194,71	
CXH91-210-810Y	30	Q _o	758492	638752	534320	443529	364711	
		P _e	118,50	116,30	114,69	113,33	111,90	
	40	Q _o	845790	714930	600298	500226	413044	337086
		P _e	150,76	147,59	145,16	143,13	141,19	139,02
	50	Q _o	783855	659969	551561	456962	374506	302523
		P _e	185,64	182,49	179,91	177,57	175,14	172,31
	60	Q _o	709520	593722	492652	404643	328026	
		P _e	229,55	226,52	223,88	221,32	218,51	
CXH91-240-912Y	30	Q _o	810189	683511	572341	475097	390194	
		P _e	126,58	124,83	122,97	121,04	119,10	
	40	Q _o	905145	766194	643839	536499	442590	360528
		P _e	160,54	157,64	154,95	152,54	150,46	148,78
	50	Q _o	841139	709341	593648	492474	404237	327355
		P _e	198,70	195,11	192,14	189,84	188,27	187,49
	60	Q _o	763503	641198	534502	441832	361605	
		P _e	244,80	241,19	238,59	237,05	236,65	

- ⑧ Per dati di prestazione in punti operativi diversi vedi Frascold Selection Software.
- ⑨ Sono riportati solo i dati dei modelli con motore taglia 1. Per i dati di prestazione dei modelli con motore taglia 2 vedi Frascold Selection Software.

- ⑧ Performance data for individual conditions see Frascold Selection Software.
- ⑨ Data referred to models with motor size 1. For data of the models with motor size 2 see Frascold Selection Software.

- ⑧ Leistungsdaten für individuelle Betriebsbedingungen siehe Frascold Selection Software.
- ⑨ Daten gelten für Verdichter mit Motor Version 1. Für Verdichter mit Motor Version 2 siehe Frascold Selection Software.

Con raffreddatore d'olio

With oil cooler

Mit Ölkühler

R407C • 60 Hz

Senza economizzatore Without economiser Ohne Economizer

Prestazioni
Performance
Leistungswerte

Dati riferiti con surriscaldamento 10 K, senza sottoraffreddamento del liquido

Data referred to 10 K superheat, without liquid subcooling

Bezogen auf 10 K Sauggas-Überhitzung, ohne Flüssigkeits-Unterkuhlung

Compressore Compressor Verdichter	Condensazione Condensing Verflüssigungs- temperatur °C	Q _o (Watt) P _e (kW) 60 Hz ↓	Potenza frigorifera [Ⓢ] Potenza assorbita [Ⓢ]		Cooling capacity [Ⓢ] Power consumption [Ⓢ]		Kälteleistung [Ⓢ] Leistungsaufnahme [Ⓢ]		
			Temperatura di evaporazione °C		Evaporating temperature °C		Verdampfungstemperatur °C		
			10	5	0	-5	-10	-15	-20
CXH02-70-199Y	30	Q _o	297488	246483	204065	168527	138160	111257	86108
		P _e	45,81	42,93	40,76	39,14	37,94	37,02	36,23
	40	Q _o	264553	218670	180317	147786	119369	93357	68042
		P _e	54,18	52,27	50,72	49,39	48,14	46,82	45,30
	50	Q _o	228543	187638	153205	123536	96924	71659	46034
		P _e	66,17	64,74	63,34	61,82	60,04	57,86	55,13
55	Q _o	209619	171148	138621	110330	84566	59620		
	P _e	73,20	71,84	70,33	68,54	66,32	63,52		
CXH02-80-230Y	30	Q _o	342305	285347	236546	194866	159271	128725	102194
		P _e	52,62	49,82	47,67	45,98	44,59	43,29	41,92
	40	Q _o	306455	253449	208359	170150	137784	110227	86444
		P _e	61,46	59,36	57,81	56,64	55,65	54,68	53,53
	50	Q _o	264517	216646	176449	142892	114938	91551	71697
		P _e	74,10	72,56	71,49	70,69	69,99	69,20	68,15
55	Q _o	242192	197331	160024	129236	103930	83072		
	P _e	82,13	80,83	79,94	79,28	78,67	77,94		
CXH02-90-264Y	30	Q _o	396989	330923	274179	225725	184529	149560	119785
		P _e	59,55	56,78	54,40	52,34	50,55	48,95	47,47
	40	Q _o	355128	293777	241473	197184	159879	128526	102092
		P _e	70,09	67,68	65,70	64,09	62,79	61,72	60,82
	50	Q _o	306672	251205	204510	165555	133309	106740	84816
		P _e	85,26	83,34	81,89	80,86	80,18	79,77	79,57
55	Q _o	280904	228817	185365	149515	120237	96498		
	P _e	95,40	93,77	92,64	91,94	91,61	91,58		
CXH02-100-298Y	30	Q _o	450263	375139	310970	256256	209499	169201	133865
		P _e	66,13	62,59	59,91	57,81	56,01	54,23	52,18
	40	Q _o	403031	333173	273930	223802	181293	144905	113138
		P _e	77,42	74,67	72,71	71,28	70,08	68,83	67,25
	50	Q _o	347818	284795	232046	188076	151384	120473	93846
		P _e	94,28	92,33	91,10	90,33	89,73	89,02	87,92
55	Q _o	318426	259408	210496	170192	136997	109414		
	P _e	105,52	103,96	103,10	102,67	102,37	101,93		
CXH52-110-316Y	30	Q _o	480463	400299	332247	273757	222282	175273	130183
		P _e	72,15	67,88	64,39	61,64	59,54	58,04	57,08
	40	Q _o	440171	363788	299413	244497	196493	152851	111025
		P _e	84,64	81,84	79,40	77,27	75,38	73,66	72,07
	50	Q _o	394880	321250	259525	207155	161593	120291	80700
		P _e	102,77	100,53	98,24	95,83	93,23	90,40	87,26
55	Q _o	366716	294078	233291	181809	137083	96565		
	P _e	114,13	111,83	109,27	106,38	103,10	99,36		
CXH02-120-340Y	30	Q _o	527043	440618	365489	300522	244582	196535	155248
		P _e	77,64	73,04	69,29	66,31	64,05	62,44	61,42
	40	Q _o	474439	394645	325125	264744	212370	166867	127101
		P _e	91,09	88,08	85,45	83,14	81,10	79,25	77,53
	50	Q _o	413465	339968	275723	219597	170454	127161	88585
		P _e	110,59	108,20	105,73	103,13	100,33	97,27	93,89
55	Q _o	378744	308271	246539	192414	144762	102450		
	P _e	122,80	120,35	117,60	114,49	110,95	106,92		
CXH52-125-372Y	30	Q _o	586492	489370	404888	331921	269342	216026	170847
		P _e	86,52	81,75	78,12	75,12	72,24	68,95	64,76
	40	Q _o	523675	435980	359329	292595	234653	184377	140641
		P _e	101,99	97,40	93,89	90,93	88,00	84,61	80,22
	50	Q _o	446695	369196	301145	241414	188878	142411	100886
		P _e	121,47	116,49	112,57	109,13	105,65	101,62	96,53
55	Q _o	404201	332090	268627	212686	163141	118867		
	P _e	131,95	126,68	122,36	118,48	114,53	109,99		
CXH52-140-428Y	30	Q _o	678771	566689	469296	385176	312915	251097	198307
		P _e	97,78	92,65	88,45	84,94	81,91	79,13	76,39
	40	Q _o	602879	502757	415588	339956	274445	217642	168131
		P _e	116,17	111,09	106,94	103,50	100,55	97,86	95,21
	50	Q _o	518042	429743	352661	285380	226486	174562	128194
		P _e	140,25	135,02	130,73	127,16	124,08	121,28	118,52
55	Q _o	474032	391595	319505	256349	200711	151175		
	P _e	154,60	149,22	144,79	141,08	137,86	134,92		

Ⓢ Vedi nota a pagina 25

Ⓢ See notes on page 25

Ⓢ Siehe Notes auf Seite 25

R407C • 60 Hz

Senza economizzatore Without economiser Ohne Economizer

Prestazioni
Performance
Leistungswerte

Dati riferiti con surriscaldamento 10 K, senza sottoraffreddamento del liquido
Data referred to 10 K superheat, without liquid subcooling
Bezogen auf 10 K Sauggas-Überhitzung, ohne Flüssigkeits-Unterkühlung

Compressore Compressor Verdichter	Condensazione Condensing Verflüssigungs- temperatur °C	Q _o (Watt) P _e (kW) 60 Hz ↓	Potenza frigorifera ⑧ Potenza assorbita ⑧			Cooling capacity ⑧ Power consumption ⑧			Kälteleistung ⑧ Leistungsaufnahme ⑧	
			Temperatura di evaporazione °C			Evaporating temperature °C			Verdampfungstemperatur °C	
			10	5	0	-5	-10	-15	-20	
CXH52-160-468Y	30	Q _o	733223	612491	507248	416149	337848	271001	214262	
		P _e	106,31	100,42	95,90	92,41	89,59	87,11	84,63	
	40	Q _o	654841	546049	451050	368499	297052	235362	182086	
		P _e	127,13	121,23	116,51	112,65	109,28	106,09	102,71	
	50	Q _o	564581	468484	384484	311237	247397	191620	142560	
		P _e	153,72	147,96	143,22	139,14	135,40	131,65	127,54	
	55	Q _o	515609	426142	347925	279612	219859	167321		
		P _e	167,84	162,22	157,52	153,41	149,54	145,57		
	CXH92-180-545Y	30	Q _o	846037	707300	586630	482290	392544	315656	249887
			P _e	122,81	115,81	110,25	105,85	102,35	99,47	96,94
40		Q _o	762161	633871	522021	424873	340690	267735	204272	
		P _e	144,93	140,11	135,97	132,24	128,65	124,93	120,81	
50		Q _o	663627	545570	442324	352151	273315	204079	142707	
		P _e	176,63	172,70	168,70	164,36	159,41	153,58	146,60	
55		Q _o	607583	494562	395537	308771	232528	165070		
		P _e	195,52	191,56	187,15	182,03	175,92	168,55		
CXH92-210-620Y		30	Q _o	975622	815793	676858	556800	453603	365251	289727
			P _e	143,03	134,31	127,69	122,42	117,73	112,86	107,03
	40	Q _o	873813	727136	599277	488217	391942	308435	235678	
		P _e	168,39	160,74	154,77	149,69	144,76	139,19	132,23	
	50	Q _o	753228	620645	504803	403685	315274	237553	168507	
		P _e	202,85	195,29	188,95	183,07	176,89	169,63	160,53	
	55	Q _o	686077	560896	451416	355621	271495	197021		
		P _e	222,70	214,80	207,90	201,25	194,06	185,58		
	CXH92-240-702Y	30	Q _o	1098828	918864	762350	627092	510895	411566	326910
			P _e	159,14	149,85	142,70	136,93	131,81	126,59	120,51
40		Q _o	982756	819359	676949	553334	446319	353710	273313	
		P _e	188,77	180,11	173,43	167,99	163,03	157,82	151,61	
50		Q _o	851011	705176	577868	466893	370056	285164	210022	
		P _e	228,06	219,90	213,56	208,30	203,38	198,05	191,56	
55		Q _o	779661	642982	523598	419316	327942	247282		
		P _e	252,16	244,19	237,98	232,76	227,80	222,36		
CXH92-280-810Y		30	Q _o	1257871	1053460	875603	721652	588958	474873	376750
			P _e	182,69	171,41	162,33	155,14	149,56	145,29	142,05
	40	Q _o	1131124	942312	777790	634911	511026	403488	309649	
		P _e	214,19	205,39	197,77	191,05	184,92	179,10	173,29	
	50	Q _o	987331	814394	663486	531957	417161	316447	227170	
		P _e	258,34	249,83	241,49	233,03	224,17	214,60	204,04	
	55	Q _o	907942	743048	599051	473302	363153	265957		
		P _e	284,08	274,89	265,37	255,23	244,17	231,91		
	CXH92-300-912Y	30	Q _o	1406157	1177650	978777	806637	658332	530961	421626
			P _e	201,30	189,99	180,84	173,37	167,09	161,49	156,10
40		Q _o	1262806	1053873	871933	714088	577436	459079	356117	
		P _e	238,85	229,06	220,86	213,77	207,28	200,92	194,18	
50		Q _o	1107438	918343	753601	610312	485578	376498	280173	
		P _e	289,59	280,84	273,11	265,91	258,74	251,13	242,56	
55		Q _o	1024275	845197	689152	553241	434564	330221		
		P _e	320,35	311,94	304,26	296,82	289,14	280,71		

⑧ Per dati di prestazione in punti operativi diversi vedi Frascold Selection Software.

⑧ Performance data for individual conditions see Frascold Selection Software.

⑧ Leistungsdaten für individuelle Betriebsbedingungen siehe Frascold Selection Software.

Con raffreddatore d'olio

With oil cooler

Mit Ölkühler

Con raffreddatore d'olio o iniezione di liquido

With oil cooler or liquid injection

Mit Ölkühler oder Flüssigkeitseinspritzung

R407C • 60 Hz

Con economizzatore With economiser Mit Economizer

**Prestazioni
Performance
Leistungswerte**

Dati riferiti con surriscaldamento 10 K, con sottoraffreddamento del liquido

Data referred to 10 K superheat, with liquid subcooling

Bezogen auf 10 K Sauggas-Überhitzung, mit Flüssigkeits-Unterkühlung

Compressore Compressor Verdichter	Condensazione Condensing Verflüssigungs- temperatur °C	Q _o (Watt) P _e (kW) 60 Hz ↓	Potenza frigorifera ⑧ Potenza assorbita ⑨		Cooling capacity ⑧ Power consumption ⑨		Kälteleistung ⑧ Leistungsaufnahme ⑨		
			Temperatura di evaporazione °C		Evaporating temperature °C		Verdampfungstemperatur °C		
			10	5	0	-5	-10	-15	-20
CXH02-70-199Y	30	Q _o	307870	263677	224347	189451	158563	131254	107095
		P _e	47,13	44,67	43,20	42,43	42,06	41,78	41,30
	40	Q _o	289676	247661	209955	176130	145760	118415	93668
		P _e	57,35	56,55	56,18	55,94	55,54	54,67	53,04
	50	Q _o	267215	226663	189867	156400	125833	97738	71688
		P _e	73,89	73,80	73,60	72,96	71,60	69,22	65,51
	55	Q _o	253177	213089	176480	142923	111990	83252	
		P _e	84,30	84,23	83,75	82,57	80,39	76,90	
CXH02-80-230Y	30	Q _o	356598	305827	260578	220358	184670	153023	124921
		P _e	54,54	51,82	50,30	49,50	48,94	48,14	46,61
	40	Q _o	336543	287814	244087	204869	169665	137983	109327
		P _e	66,78	65,49	64,93	64,61	64,03	62,73	60,21
	50	Q _o	306886	260669	218936	181193	146945	115699	86961
		P _e	86,04	85,34	84,87	84,15	82,70	80,03	75,67
	55	Q _o	288452	243668	203109	166280	132687	101836	
		P _e	98,09	97,36	96,62	95,38	93,16	89,49	
CXH02-90-264Y	30	Q _o	399756	341691	290587	245676	206187	171349	140394
		P _e	60,76	57,54	55,56	54,45	53,85	53,37	52,63
	40	Q _o	373838	320061	272299	229782	191739	157400	125996
		P _e	74,23	71,92	70,54	69,72	69,07	68,22	66,80
	50	Q _o	342250	292577	247970	207660	170877	136850	104810
		P _e	92,50	91,18	90,47	89,99	89,37	88,23	86,19
	55	Q _o	323443	275751	232652	193376	157153	123212	
		P _e	104,29	103,49	103,14	102,86	102,28	101,01	
CXH02-100-298Y	30	Q _o	451206	385684	328009	277317	232741	193415	158475
		P _e	68,59	65,03	62,85	61,66	61,06	60,66	60,05
	40	Q _o	421991	361293	307379	259383	216441	177685	142251
		P _e	83,70	81,08	79,52	78,63	78,01	77,27	75,99
	50	Q _o	386371	330285	279919	234408	192886	154487	118347
		P _e	104,43	102,74	101,79	101,19	100,54	99,44	97,49
	55	Q _o	365147	311286	262615	218266	177375	139075	
		P _e	118,24	117,01	116,36	115,90	115,23	113,95	
CXH52-110-316Y	30	Q _o	504603	431253	367412	311166	260602	213807	168868
		P _e	73,13	70,05	68,08	66,93	66,29	65,87	65,36
	40	Q _o	481406	410440	348526	293751	244200	197960	153119
		P _e	89,77	89,02	88,60	88,22	87,59	86,41	84,37
	50	Q _o	449519	379491	318057	263303	213317	166186	119995
		P _e	116,30	116,39	116,04	114,96	112,85	109,41	104,35
	55	Q _o				240279	189532	141411	
		P _e				130,15	126,75	121,63	
CXH02-120-340Y	30	Q _o	543064	466303	397681	336478	281976	233457	190202
		P _e	78,78	75,40	73,23	71,95	71,28	70,92	70,58
	40	Q _o	517939	443580	376612	316318	261979	212875	168290
		P _e	96,42	95,61	95,21	94,90	94,40	93,42	91,65
	50	Q _o	482274	409470	343313	283082	228059	177525	130763
		P _e	124,85	124,82	124,39	123,27	121,15	117,75	112,76
	55	Q _o				259604	203922	152357	
		P _e				139,90	136,30	131,02	
CXH52-125-372Y	30	Q _o	594039	509763	434600	367743	308386	255724	208949
		P _e	84,72	80,56	78,06	76,60	75,55	74,30	72,24
	40	Q _o	561599	480717	408036	342751	284056	231145	183211
		P _e	103,66	101,25	99,86	98,87	97,67	95,65	92,17
	50	Q _o	513740	436907	367365	304308	246930	194425	145988
		P _e	131,60	129,94	128,68	127,19	124,86	121,07	115,20
	55	Q _o	483821	409258	341531	279834	223361	171306	
		P _e	148,16	146,52	144,95	142,84	139,58	134,53	
CXH52-140-428Y	30	Q _o	650670	558360	476031	402801	337785	280103	228869
		P _e	93,72	89,13	86,36	84,74	83,58	82,20	79,92
	40	Q _o	615138	526545	446935	375427	311136	253180	200677
		P _e	114,68	112,01	110,47	109,38	108,06	105,81	101,97
	50	Q _o	562717	478558	402387	333318	270471	212961	159905
		P _e	145,58	143,75	142,36	140,71	138,13	133,94	127,45
	55	Q _o	529945	448274	374090	306512	244655	187637	
		P _e	163,91	162,09	160,35	158,02	154,41	148,83	

⑧ Vedi nota a pagina 27

⑧ See notes on page 27

⑧ Siehe Notes auf Seite 27

R407C • 60 Hz

Con economizzatore With economiser Mit Economizer

Prestazioni
Performance
Leistungswerte

Dati riferiti con surriscaldamento 10 K, con sottoraffreddamento del liquido

Data referred to 10 K superheat, with liquid subcooling



Bezogen auf 10 K Sauggas-Überhitzung, mit Flüssigkeits-Unterkühlung



Compressore Compressor Verdichter	Condensazione Condensing Verflüssigungs- temperatur °C	Q _o (Watt) P _e (kW) 60 Hz ↓	Potenza frigorifera [Ⓢ] Potenza assorbita [Ⓢ]			Cooling capacity [Ⓢ] Power consumption [Ⓢ]		Kälteleistung [Ⓢ] Leistungsaufnahme [Ⓢ]		
			Temperatura di evaporazione °C			Evaporating temperature °C		Verdampfungstemperatur °C		
			10	5	0	-5	-10	-15	-20	
CXH52-160-468Y	30	Q _o	727600	621857	529191	448090	377041	314533	259053	
		P _e	105,93	100,28	96,83	94,94	93,98	93,29	92,25	
	40	Q _o	683900	585511	498240	420573	350999	288004	230079	
		P _e	129,44	125,37	122,98	121,61	120,65	119,43	117,32	
	50	Q _o	626370	535851	454489	380771	313186	250221	190365	
		P _e	162,17	159,61	158,20	157,29	156,24	154,42	151,19	
	55	Q _o	592147	505756	427542	355992	289595	226837		
		P _e	182,88	181,05	180,10	179,39	178,29	176,14		
	CXH92-180-545Y	30	Q _o	879390	754040	642300	542931	454691	376340	306639
			P _e	124,25	118,86	115,47	113,50	112,34	111,41	110,11
40		Q _o	835264	714413	605899	508483	420925	341984	270420	
		P _e	153,00	151,29	150,27	149,36	147,95	145,45	141,26	
50		Q _o	773265	655902	549605	453134	365248	284707	210270	
		P _e	196,17	196,18	195,57	193,75	190,13	184,10	175,08	
55		Q _o	732880	616884	511316	414938	326510	244790		
		P _e	222,01	222,15	221,01	218,01	212,55	204,03		
CXH92-210-620Y		30	Q _o	1000123	857170	729939	617011	516969	428395	349871
			P _e	143,09	137,69	133,31	129,86	127,27	125,43	124,26
	40	Q _o	942151	805269	682628	572810	474396	385970	306113	
		P _e	174,68	171,02	168,04	165,64	163,75	162,26	161,10	
	50	Q _o	857400	728072	611503	506276	410972	324175	244467	
		P _e	221,23	217,46	214,02	210,82	207,77	204,79	201,78	
	55	Q _o	804995	679999	567022	464646	371453	286027		
		P _e	249,30	244,78	240,42	236,12	231,80	227,37		
	CXH92-240-702Y	30	Q _o	1105867	945100	803578	679196	569848	473427	387829
			P _e	157,79	149,88	144,91	141,92	139,97	138,10	135,34
40		Q _o	1033548	884502	752187	634497	529326	434569	348119	
		P _e	192,89	186,97	183,29	180,90	178,84	176,16	171,91	
50		Q _o	944904	807314	683941	572678	471420	378062	290496	
		P _e	239,85	236,13	233,96	232,37	230,43	227,16	221,63	
55		Q _o	892354	760393	641391	533243	433842	341083		
		P _e	269,40	266,86	265,52	264,42	262,61	259,13		
CXH92-280-810Y		30	Q _o	1275893	1092271	929327	785063	657479	544578	444361
			P _e	184,82	175,47	168,87	164,44	161,61	159,79	158,40
	40	Q _o	1199246	1023276	866432	726714	602125	490666	390339	
		P _e	221,32	216,43	212,79	209,83	206,96	203,61	199,19	
	50	Q _o	1096445	929261	779649	645612	525152	416269	316966	
		P _e	277,18	273,82	270,22	265,80	259,98	252,18	241,81	
	55	Q _o	1034381	872014	726444	595673	477702	370533		
		P _e	311,58	307,90	303,22	296,98	288,58	277,46		
	CXH92-300-912Y	30	Q _o	1406119	1200611	1020030	861540	722305	599489	490255
			P _e	201,99	191,84	184,50	179,45	176,15	174,10	172,76
40		Q _o	1312645	1121164	951979	802254	669153	549840	441479	
		P _e	242,13	235,84	231,32	228,06	225,54	223,22	220,59	
50		Q _o	1205879	1027600	868987	727204	599414	482781	374469	
		P _e	302,04	298,16	295,04	292,13	288,94	284,92	279,56	
55		Q _o	1144111	972125	818489	680368	554925	439323		
		P _e	340,02	336,81	333,83	330,57	326,49	321,09		

[Ⓢ] Per dati di prestazione in punti operativi diversi vedi Frascold Selection Software.

[Ⓢ] Performance data for individual conditions see Frascold Selection Software.

[Ⓢ] Leistungsdaten für individuelle Betriebsbedingungen siehe Frascold Selection Software.

 Con raffreddatore d'olio
 Con raffreddatore d'olio o iniezione di liquido

 With oil cooler
 With oil cooler or liquid injection

 Mit Ölkühler
 Mit Ölkühler oder Flüssigkeitseinspritzung

R22 • 60 Hz

Senza economizzatore Without economiser Ohne Economizer

Prestazioni
Performance
Leistungswerte

Dati riferiti con surriscaldamento 10 K, senza sottoraffreddamento del liquido

Data referred to 10 K superheat, without liquid subcooling

Bezogen auf 10 K Sauggas-Überhitzung, ohne Flüssigkeits-Unterkuhlung

Compressore Compressor Verdichter	Condensazione Condensing Verflüssigungs- temperatur °C	Q _o (Watt) P _e (kW) 60 Hz	Potenza frigorifera ⑧ Potenza assorbita ⑨		Cooling capacity ⑧ Power consumption ⑨		Kälteleistung ⑧ Leistungsaufnahme ⑨		
			Temperatura di evaporazione °C		Evaporating temperature °C		Verdampfungstemperatur °C		
			10	5	0	-5	-10	-15	-20
CXH02-70-199Y	30	Q _o	258513	221249	184239	149799	120242	97883	
		P _e	46,27	43,97	41,99	40,35	39,06	38,11	
	40	Q _o	271830	234424	196325	159850	127314	101030	83314
		P _e	56,14	53,95	51,94	50,13	48,51	47,10	45,90
	50	Q _o	237556	200622	164367	131103	103147	82813	72416
		P _e	66,39	64,26	62,18	60,16	58,19	56,29	54,46
55	Q _o	217443	181750	147419	116766	92104	75748		
	P _e	72,46	70,22	67,97	65,70	63,42	61,14		
CXH02-80-230Y	30	Q _o	297609	255197	213274	174440	141296	116440	
		P _e	54,16	51,54	49,12	46,96	45,14	43,72	
	40	Q _o	312040	270410	227894	187091	150602	121026	100965
		P _e	66,32	63,90	61,50	59,21	57,08	55,17	53,57
	50	Q _o	275559	234736	194250	156703	124694	100823	87691
		P _e	79,01	76,61	74,13	71,65	69,23	66,94	64,84
55	Q _o	254914	215294	176625	141507	112538	92321		
	P _e	86,06	83,55	80,92	78,23	75,55	72,95		
CXH02-90-264Y	30	Q _o	338124	291275	245066	201957	164405	134869	
		P _e	60,19	58,10	56,09	54,16	52,31	50,55	
	40	Q _o	358527	312145	264953	219410	177975	143106	117260
		P _e	73,61	71,90	70,07	68,10	66,02	63,83	61,52
	50	Q _o	321519	275639	229958	186934	149025	118691	98389
		P _e	89,20	87,30	85,07	82,52	79,65	76,47	72,97
55	Q _o	299370	254436	210204	169134	133684	106312		
	P _e	98,05	95,82	93,15	90,07	86,57	82,65		
CXH02-100-298Y	30	Q _o	381679	328795	276634	227971	185581	152241	
		P _e	67,94	65,59	63,32	61,14	59,05	57,06	
	40	Q _o	404709	352353	299082	247673	200900	161539	132366
		P _e	83,09	81,17	79,09	76,88	74,53	72,05	69,44
	50	Q _o	362935	311145	259579	211013	168221	133980	111064
		P _e	100,69	98,54	96,03	93,15	89,91	86,32	82,37
55	Q _o	337933	287210	237281	190921	150904	120007		
	P _e	110,68	108,16	105,15	101,67	97,72	93,30		
CXH52-110-316Y	30	Q _o	422752	361848	301345	245020	196650	160011	
		P _e	72,39	68,77	65,68	63,13	61,11	59,63	
	40	Q _o	444467	383326	321055	261430	208228	165226	136201
		P _e	87,77	84,32	81,19	78,37	75,87	73,70	71,84
	50	Q _o	388521	328113	268820	214417	168683	135393	118326
		P _e	103,79	100,44	97,20	94,06	91,02	88,09	85,26
55	Q _o	355672	297260	241084	190922	150551	123746		
	P _e	113,31	109,80	106,27	102,75	99,21	95,68		
CXH02-120-340Y	30	Q _o	454908	389372	324267	263657	211608	172182	
		P _e	77,89	74,00	70,68	67,93	65,76	64,16	
	40	Q _o	478275	412484	345477	281316	224067	177794	146560
		P _e	94,44	90,73	87,36	84,33	81,65	79,30	77,30
	50	Q _o	418074	353071	289267	230726	181513	145691	127324
		P _e	111,68	108,08	104,59	101,21	97,94	94,79	91,74
55	Q _o	382726	319871	259422	205444	162001	133158		
	P _e	121,93	118,15	114,36	110,56	106,76	102,96		
CXH52-125-372Y	30	Q _o	493905	424205	355439	291247	235271	191151	
		P _e	86,09	81,97	78,26	74,95	72,02	69,43	
	40	Q _o	518791	449888	379934	312569	251435	200171	162419
		P _e	105,52	101,70	98,02	94,48	91,06	87,73	84,47
	50	Q _o	459604	391749	324498	261492	206372	162779	134352
		P _e	125,82	122,08	118,21	114,19	110,01	105,65	101,08
55	Q _o	425402	359180	294390	234673	183670	145020		
	P _e	137,09	133,15	128,94	124,45	119,65	114,53		
CXH52-140-428Y	30	Q _o	564651	486190	408873	336908	274505	225871	
		P _e	96,11	92,74	89,48	86,39	83,51	80,89	
	40	Q _o	598521	521220	442456	366439	297376	239478	196952
		P _e	117,52	114,82	111,89	108,75	105,45	102,05	98,59
	50	Q _o	537237	460670	384245	312168	248649	197897	164120
		P _e	142,53	139,48	135,86	131,73	127,12	122,09	116,67
55	Q _o	500292	425084	350818	281701	221944	175756		
	P _e	156,67	153,02	148,65	143,60	137,92	131,65		

⑧ Vedi nota a pagina 29

⑨ See notes on page 29

⑩ Siehe Notes auf Seite 29

R22 • 60 Hz

Prestazioni
Performance
Leistungswerte
Senza economizzatore Without economiser Ohne Economizer

Dati riferiti con surriscaldamento 10 K, senza sottoraffreddamento del liquido

Data referred to 10 K superheat, without liquid subcooling

Bezogen auf 10 K Sauggas-Überhitzung, ohne Flüssigkeits-Unterkühlung

Compressore Compressor Verdichter	Condensazione Condensing Verflüssigungs- temperatur °C	Q _o (Watt) P _e (kW) 60 Hz ↓	Potenza frigorifera [Ⓢ] Potenza assorbita [Ⓢ]			Cooling capacity [Ⓢ] Power consumption [Ⓢ]			Kälteleistung [Ⓢ] Leistungsaufnahme [Ⓢ]		
			Temperatura di evaporazione °C		Evaporating temperature °C			Verdampfungstemperatur °C			
			10	5	0	-5	-10	-15	-20		
CXH52-160-468Y	30	Q _o	616539	529679	445611	368016	300576	246973			
		P _e	105,09	101,41	97,85	94,47	91,32	88,45			
	40	Q _o	656162	569496	483066	400553	325640	262008	213338		
		P _e	128,51	125,56	122,35	118,91	115,31	111,59	107,80		
	50	Q _o	587554	503204	420217	342273	273054	216241	175517		
		P _e	155,86	152,52	148,56	144,04	139,01	133,50	127,58		
	55	Q _o	546006	463944	383808	309277	244035	191762			
		P _e	171,32	167,33	162,54	157,02	150,81	143,96			
	CXH92-180-545Y	30	Q _o	736775	630714	525363	427298	343097	279337		
			P _e	123,80	117,71	112,48	108,12	104,60	101,93		
		40	Q _o	774853	668355	559902	456074	363445	288594	238097	
			P _e	150,26	144,42	139,09	134,24	129,89	126,00	122,58	
50		Q _o	677751	572511	469232	374489	294860	236922	207252		
		P _e	177,74	172,02	166,44	160,97	155,61	150,34	145,17		
55		Q _o	620737	518963	421105	333742	263449	216804			
		P _e	193,99	187,96	181,87	175,71	169,47	163,14			
CXH92-210-620Y		30	Q _o	831990	714012	597867	490031	396983	325200		
			P _e	142,38	135,49	129,29	123,85	119,26	115,60		
		40	Q _o	873581	758072	640373	526959	424310	338903	277217	
			P _e	174,45	168,35	162,30	156,40	150,73	145,36	140,39	
	50	Q _o	775429	661469	547773	440817	347081	273042	225178		
		P _e	208,35	202,26	195,70	188,74	181,46	173,96	166,31		
	55	Q _o	718178	606390	496093	393764	305881	238923			
		P _e	226,96	220,37	213,03	205,03	196,45	187,37			
	CXH92-240-702Y	30	Q _o	935988	805975	677861	558619	455222	374643		
			P _e	156,27	150,89	145,70	140,73	136,01	131,58		
		40	Q _o	992286	864159	733633	607683	493280	397398	327010	
			P _e	191,34	186,98	182,24	177,15	171,75	166,06	160,14	
50		Q _o	891024	764093	637439	518036	412857	328874	273061		
		P _e	232,02	227,08	221,23	214,49	206,91	198,52	189,36		
55		Q _o	829986	705297	582223	467737	368814	292425			
		P _e	254,88	249,00	241,94	233,73	224,41	214,01			
CXH92-280-810Y		30	Q _o	1040963	897454	755707	623528	508724	419100		
			P _e	179,69	172,60	166,04	160,36	155,94	153,16		
		40	Q _o	1108589	964761	818271	676924	548528	440889	361814	
			P _e	215,72	212,14	207,36	201,76	195,71	189,58	183,73	
	50	Q _o	1003247	857332	712138	575470	455136	358941	294694		
		P _e	262,03	257,77	250,98	242,02	231,26	219,08	205,84		
	55	Q _o	938359	793006	650064	517340	402641	313773			
		P _e	287,96	281,74	272,32	260,05	245,32	228,49			
	CXH92-300-912Y	30	Q _o	1164535	1004519	846661	698972	569461	466138		
			P _e	198,31	191,40	184,76	178,55	172,89	167,92		
		40	Q _o	1240267	1080183	918067	761930	619781	499630	409488	
			P _e	240,81	236,55	231,44	225,61	219,19	212,31	205,12	
50		Q _o	1126195	965469	806531	657393	526062	420550	348866		
		P _e	293,41	288,82	282,37	274,19	264,41	253,18	240,62		
55		Q _o	1057165	898098	742729	599068	475127	378913			
		P _e	322,90	316,97	308,66	298,13	285,50	270,91			

[Ⓢ] Per dati di prestazione in punti operativi diversi vedi Frascold Selection Software.

[Ⓢ] Performance data for individual conditions see Frascold Selection Software.

[Ⓢ] Leistungsdaten für individuelle Betriebsbedingungen siehe Frascold Selection Software.

 Con raffreddatore d'olio

 With oil cooler

 Mit Ölkühler

 Con raffreddatore d'olio o iniezione di liquido

 With oil cooler or liquid injection

 Mit Ölkühler oder Flüssigkeitseinspritzung

R22 • 60 Hz

Con economizzatore With economiser Mit Economizer

Prestazioni

Performance

Leistungswerte

Dati riferiti con surriscaldamento 10 K, con sottoraffreddamento del liquido

Data referred to 10 K superheat, with liquid subcooling

Bezogen auf 10 K Sauggas-Überhitzung, mit Flüssigkeits-Unterkühlung

Compressore Compressor Verdichter	Condensazione Condensing Verflüssigungs- temperatur °C	Q _o (Watt) P _e (kW) 60 Hz	Potenza frigorifera ⑧ Potenza assorbita ⑧		Cooling capacity ⑧ Power consumption ⑧		Kälteleistung ⑧ Leistungsaufnahme ⑧		
			Temperatura di evaporazione °C		Evaporating temperature °C		Verdampfungstemperatur °C		
			10	5	0	-5	-10	-15	-20
CXH02-70-199Y	30	Q _o	272455	238178	203182	169687	139916	116089	
		P _e	47,58	46,06	44,95	44,13	43,47	42,84	
	40	Q _o	294439	259153	222307	186122	152819	124620	103746
		P _e	59,01	57,84	56,91	56,08	55,24	54,24	52,96
	50	Q _o	271230	234594	197777	163003	132491	108463	93141
		P _e	73,26	72,35	71,37	70,18	68,66	66,68	64,10
	55	Q _o	255996	219660	183833	150738	122596	101629	
		P _e	82,04	81,03	79,78	78,17	76,07	73,35	
CXH02-80-230Y	30	Q _o	308224	269579	231320	194969	162046	134075	
		P _e	55,06	53,41	52,12	51,01	49,92	48,67	
	40	Q _o	332873	292966	252834	213998	177982	146305	120490
		P _e	68,99	67,85	66,94	66,07	65,08	63,79	62,02
	50	Q _o	307709	267746	228470	191401	158062	129974	108659
		P _e	86,48	85,96	85,35	84,47	83,15	81,21	78,48
	55	Q _o	291922	252810	214841	179534	148412	122997	
		P _e	97,00	96,63	96,00	94,95	93,30	90,88	
CXH02-90-264Y	30	Q _o	345059	301401	259044	219622	184700	156122	
		P _e	60,88	58,85	57,58	56,73	55,95	54,90	
	40	Q _o	372942	329937	286609	244592	205521	171029	142753
		P _e	74,81	73,65	73,00	72,53	71,90	70,75	68,74
	50	Q _o	349234	306497	263447	221718	182945	148763	120806
		P _e	93,07	92,70	92,26	91,41	89,81	87,10	82,96
	55	Q _o	333892	291270	248339	206735	168092	134045	
		P _e	104,29	103,87	103,09	101,61	99,07	95,15	
CXH02-100-298Y	30	Q _o	389506	340225	292412	247911	208570	176231	
		P _e	68,72	66,43	64,99	64,03	63,16	61,98	
	40	Q _o	420981	372437	323528	276098	231994	193059	161140
		P _e	84,45	83,14	82,41	81,88	81,16	79,86	77,60
	50	Q _o	394220	345978	297382	250278	206510	167925	136366
		P _e	105,06	104,64	104,15	103,19	101,38	98,32	93,64
	55	Q _o	376902	328789	280328	233365	189744	151310	
		P _e	117,72	117,25	116,37	114,70	111,84	107,41	
CXH52-110-316Y	30	Q _o	444944	389201	332325	277798	229101	189716	
		P _e	74,47	72,13	70,45	69,20	68,14	67,03	
	40	Q _o	482268	424374	364178	305164	250812	204603	170019
		P _e	92,47	90,70	89,33	88,14	86,87	85,31	83,20
	50	Q _o	445816	385218	324633	267542	217426	177767	152047
		P _e	114,99	113,64	112,20	110,43	108,10	104,98	100,81
	55	Q _o	421066	360640	301383	246776	200302	165442	
		P _e	128,79	127,26	125,38	122,94	119,69	115,39	
CXH02-120-340Y	30	Q _o	478788	418805	357603	298928	246527	204147	
		P _e	80,13	77,61	75,81	74,46	73,32	72,13	
	40	Q _o	518951	456653	391880	328376	269889	220166	182951
		P _e	99,50	97,60	96,13	94,84	93,48	91,79	89,52
	50	Q _o	479727	414520	349326	287892	233964	191289	163612
		P _e	123,73	122,28	120,73	118,83	116,33	112,96	108,48
	55	Q _o	453094	388072	324307	265547	215537	178024	
		P _e	138,59	136,94	134,92	132,29	128,79	124,17	
CXH52-125-372Y	30	Q _o	513618	450654	386444	324842	269702	224876	
		P _e	87,60	84,81	82,57	80,69	78,97	77,20	
	40	Q _o	554709	490411	423422	357595	296785	244845	205628
		P _e	109,63	107,57	105,81	104,16	102,42	100,40	97,88
	50	Q _o	516442	449585	382445	318877	262733	217868	188134
		P _e	136,22	134,85	133,35	131,51	129,14	126,04	122,00
	55	Q _o	490925	424242	358480	297494	245136	205261	
		P _e	151,59	150,28	148,61	146,39	143,41	139,48	
CXH52-140-428Y	30	Q _o	575410	502618	432182	366708	308803	261073	
		P _e	97,24	93,91	91,84	90,50	89,34	87,82	
	40	Q _o	622508	550566	478360	408497	343582	286221	239022
		P _e	119,44	117,58	116,56	115,83	114,85	113,09	109,99
	50	Q _o	585171	513282	441115	371276	306371	249007	201790
		P _e	148,74	148,21	147,55	146,21	143,65	139,33	132,71
	55	Q _o	561232	489164	416811	346778	281673	224101	
		P _e	166,81	166,22	165,01	162,63	158,55	152,22	

⑧ Vedi nota a pagina 31

⑧ See notes on page 31

⑧ Siehe Notes auf Seite 31

R22 • 60 Hz

Con economizzatore With economiser Mit Economizer

Prestazioni
Performance
Leistungswerte

Dati riferiti con surriscaldamento 10 K, con sottoraffreddamento del liquido

Data referred to 10 K superheat, with liquid subcooling

Bezogen auf 10 K Sauggas-Überhitzung, mit Flüssigkeits-Unterkühlung

Compressore Compressor Verdichter	Condensazione Condensing Verflüssigungs- temperatur °C	Q _o (Watt) P _e (kW) 60 Hz ↓	Potenza frigorifera ⑧ Potenza assorbita ⑧		Cooling capacity ⑧ Power consumption ⑧		Kälteleistung ⑧ Leistungsaufnahme ⑧		
			Temperatura di evaporazione °C		Evaporating temperature °C		Verdampfungstemperatur °C		
			10	5	0	-5	-10	-15	-20
CXH52-160-468Y	30	Q _o	629796	550054	472780	400917	337412	285207	
		P _e	106,33	102,69	100,43	98,96	97,69	96,03	
	40	Q _o	680752	602487	523633	447135	375938	312985	261221
		P _e	130,61	128,57	127,45	126,66	125,59	123,66	120,28
	50	Q _o	638685	560961	482536	406355	335362	272502	220720
		P _e	162,65	162,07	161,35	159,88	157,08	152,36	145,12
	55	Q _o	611531	533904	455521	379326	308264	245278	
		P _e	182,41	181,76	180,44	177,84	173,37	166,45	
	CXH92-180-545Y	30	Q _o	774993	677237	577663	482530	398096	330618
			P _e	127,27	123,22	120,25	118,02	116,16	114,30
40		Q _o	836477	736204	631680	529162	434910	355182	296236
		P _e	157,67	154,42	151,86	149,63	147,35	144,67	141,23
50		Q _o	769933	665899	561439	462811	376273	308084	264502
		P _e	194,75	192,16	189,49	186,37	182,44	177,33	170,69
55		Q _o	725954	622603	520738	426617	346498	286641	
		P _e	217,34	214,47	211,14	206,97	201,61	194,69	
CXH92-210-620Y		30	Q _o	864631	757744	649028	545136	452717	378422
			P _e	145,05	140,39	136,55	133,31	130,44	127,71
	40	Q _o	930443	822175	709361	598652	496698	410151	345659
		P _e	180,77	177,16	173,97	170,99	167,98	164,73	161,02
	50	Q _o	863299	751209	638506	531841	437864	363225	314575
		P _e	223,48	220,74	217,82	214,48	210,51	205,67	199,75
	55	Q _o	819742	708006	597623	495243	407518	341098	
		P _e	248,30	245,56	242,31	238,35	233,44	227,35	
	CXH92-240-702Y	30	Q _o	954719	833589	716182	607014	510602	431462
			P _e	158,15	152,96	149,64	147,35	145,26	142,52
40		Q _o	1031210	911941	791934	675706	567773	472651	394858
		P _e	194,47	191,41	189,61	188,22	186,42	183,38	178,25
50		Q _o	964709	846356	727322	612122	505273	411291	334693
		P _e	241,53	240,24	238,75	236,25	231,89	224,84	214,25
55/30		Q _o	921796	803845	685240	570498	464134	370666	
		P _e	270,05	268,49	266,02	261,82	255,03	244,82	
CXH92-280-810Y		40	Q _o	1077009	946460	813740	686650	572992	480568
			P _e	182,39	177,94	174,23	171,09	168,36	165,91
	50	Q _o	1173040	1037219	896647	759125	632456	524441	442883
		P _e	222,93	222,04	220,60	218,44	215,42	211,38	206,18
	55	Q _o	1103416	959403	815862	680593	561400	466083	402446
		P _e	278,64	278,32	276,00	271,54	264,77	255,55	243,73
	30	Q _o	1053613	908150	765769	634273	521463	435141	
		P _e	311,00	309,51	305,30	298,23	288,15	274,89	
	CXH92-300-912Y	40	Q _o	1185636	1035817	890354	754527	633620	532914
			P _e	199,57	193,97	189,53	185,92	182,84	179,97
50		Q _o	1284524	1133852	983456	838615	704613	586732	490252
		P _e	244,49	242,47	240,44	238,10	235,13	231,22	226,05
55		Q _o	1209104	1057233	906837	763199	631600	517322	425648
		P _e	303,42	303,16	301,42	297,90	292,28	284,24	273,48
		Q _o	1160083	1007829	857651	714831	584651	472392	
		P _e	337,49	336,87	334,04	328,70	320,52	309,19	

⑧ Per dati di prestazione in punti operativi diversi vedi Frascold Selection Software.

⑧ Performance data for individual conditions see Frascold Selection Software.

⑧ Leistungsdaten für individuelle Betriebsbedingungen siehe Frascold Selection Software.

Con raffreddatore d'olio

With oil cooler

Mit Ölkühler

Con raffreddatore d'olio o iniezione di liquido

With oil cooler or liquid injection

Mit Ölkühler oder Flüssigkeitseinspritzung

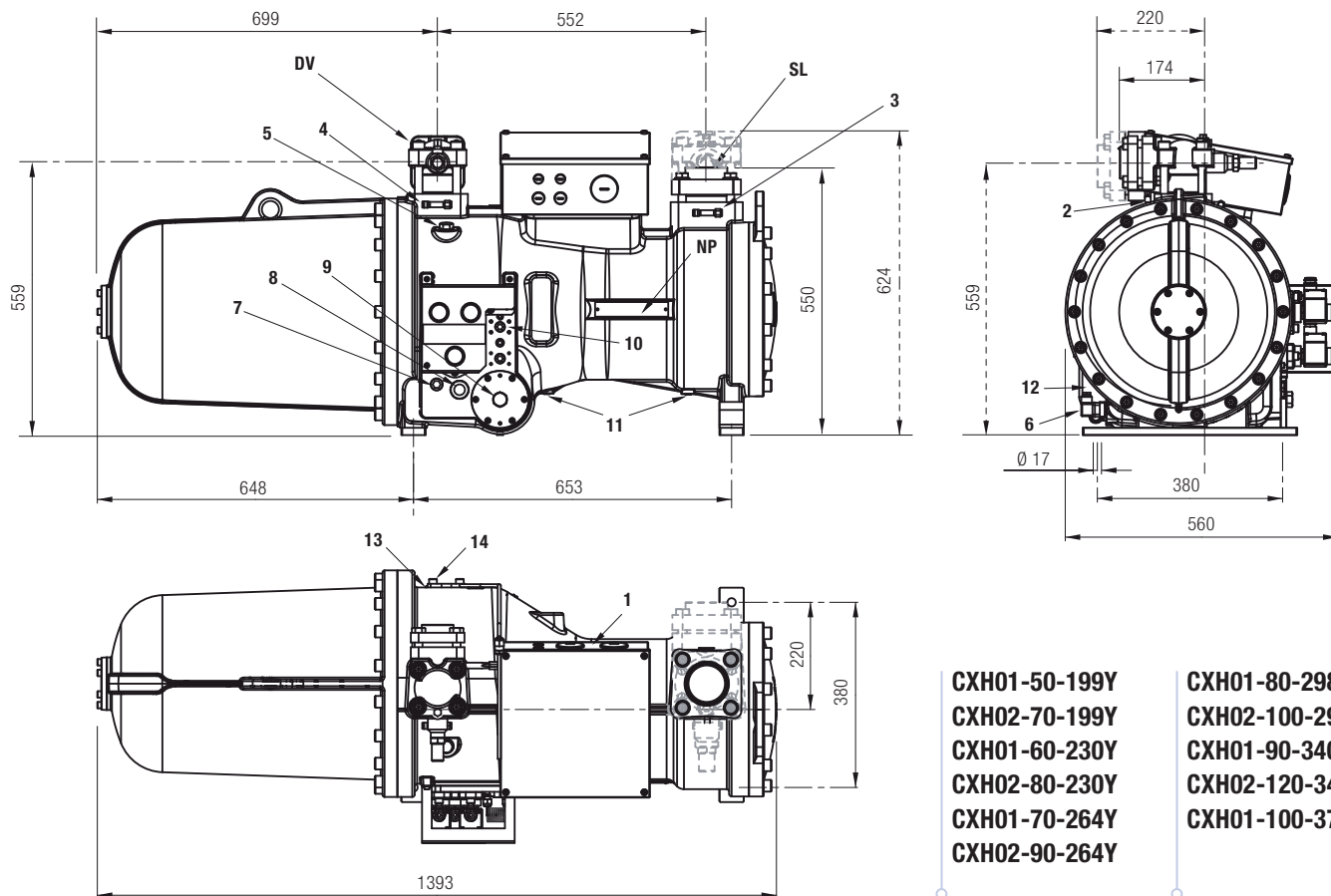

CXH01-50-199Y
CXH02-70-199Y
CXH01-60-230Y
CXH02-80-230Y
CXH01-70-264Y
CXH02-90-264Y

CXH01-80-298Y
CXH02-100-298Y
CXH01-90-340Y
CXH02-120-340Y
CXH01-100-370Y

1	attacco di bassa pressione	low pressure connection	Saugseiteanschluß	1/8" NPT
2	attacco di alta pressione	high pressure connection	Druckseiteanschluß	1/8" NPT
3	attacco di bassa pressione	low pressure connection	Saugseiteanschluß	1/4" SAE x 1/4" SAE
4	attacco di alta pressione	high pressure connection	Druckseiteanschluß	1/4" SAE x 1/4" SAE
5	tappo carico olio	oil charge plug	Stopfen Ölfüllung	3/8" GAS
6	resistenza riscaldamento olio	crankcase heater	Ölsumpfheizung	
7	attacco per controllo livello olio	oil level monitoring connection	Ölniveau-überwachungsanschluß	M12 x 1.5
8	spia livello olio	oil level sight glass	Ölschauglas	
9	attacco per sensore intasamento filtro	connection for filter clogging sensor	Verstopfungszeigerfühleranschluß	1/2" GAS
10	attacchi per raffreddatore olio	connection for oil cooler	Ölkülerschluße	1/2" NPT
11	attacchi per scarico olio	connection for oil drain	Ölablass-Stopfen	1/4" NPT
12	valvola per scarico olio	oil drain valve	Ölablassventil	1/8" NPT
13	sensore massima temperatura olio	maximum oil temperature sensor	Maximale Öltemperatur-Sensor	
14	attacco per ECO / iniezione di liquido	connection for ECO / liquid injection	Economizer-Flüssigkeitseinspritzungsanschluß	Ø 1" 1/4
DV	rubinetto di compressione	discharge valve	Druckventil	54,0 mm - 2" 1/8
NP	targhetta	name plate	Verdichtertypschild	
SL	attacco di aspirazione	suction connection	Sauganschluß	79,4 mm - 3" 1/8

Dimensioni di ingombro
Dimensional drawing
Maßzeichnungen

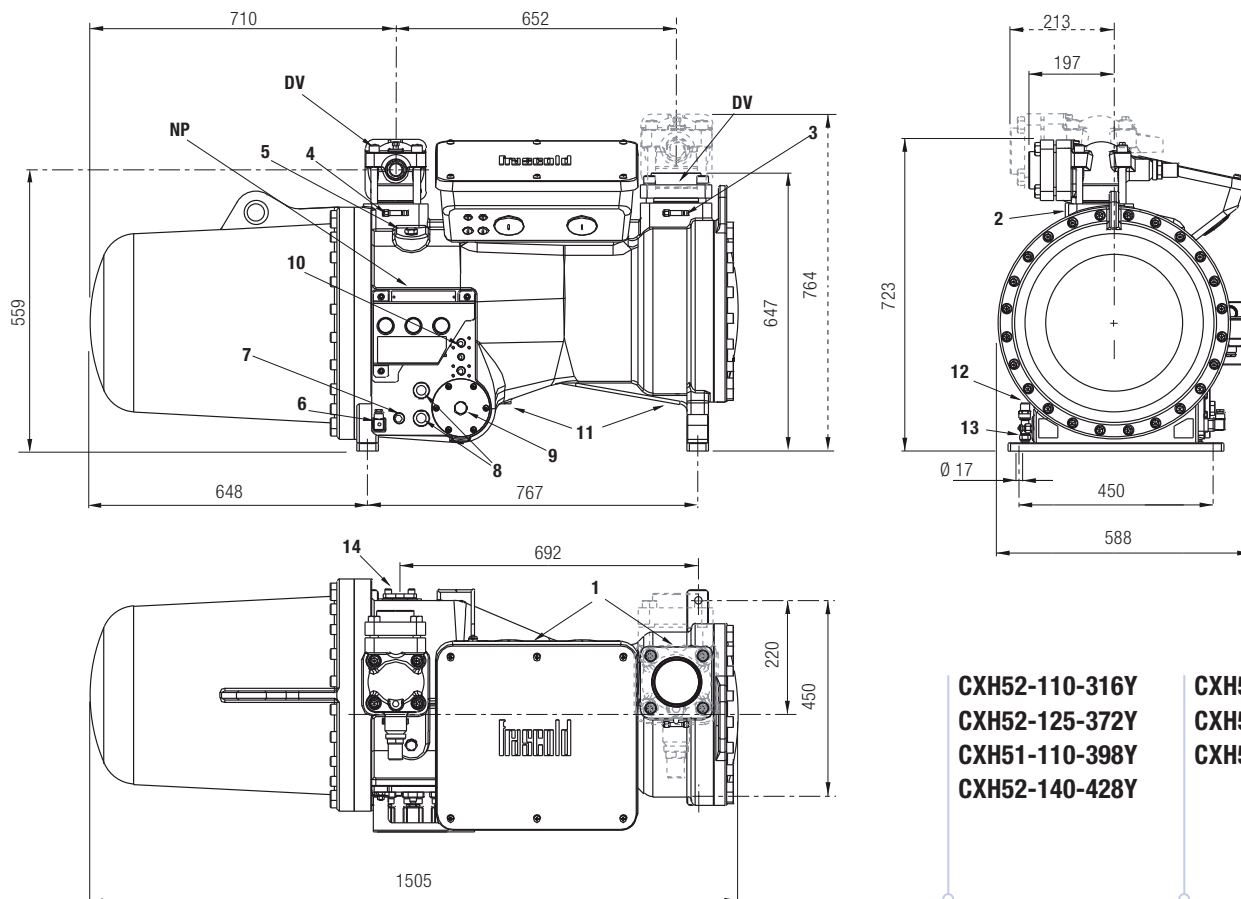

CXH52-110-316Y
CXH52-125-372Y
CXH51-110-398Y
CXH52-140-428Y

CXH51-125-468Y
CXH52-160-468Y
CXH51-140-538Y

1	attacco di bassa pressione	low pressure connection	Saugseiteanschluß	1/8" NPT
2	attacco di alta pressione	high pressure connection	Druckseiteanschluß	1/8" NPT
3	attacco di bassa pressione	low pressure connection	Saugseiteanschluß	1/4" SAE x 1/4" SAE
4	attacco di alta pressione	high pressure connection	Druckseiteanschluß	1/4" SAE x 1/4" SAE
5	tappo carico olio	oil charge plug	Stopfen Örfüllung	3/8" GAS
6	resistenza riscaldamento olio	crankcase heater	Ölumpfheizung	
7	attacco per controllo livello olio	oil level monitoring connection	Ölniveau-überwachunganschluß	M12 x 1.5
8	spia livello olio	oil level sight glass	Ölschauglas	
9	attacco per sensore intasamento filtro	connection for filter clogging sensor	Verstopfungszeigerfühleranschluß	1/2" GAS
10	attacchi per raffreddatore olio	connection for oil cooler	Ölkülerschluße	1/2" NPT
11	attacchi per scarico olio	connection for oil drain	Ölablass-Stopfen	1/4" NPT
12	valvola per scarico olio	oil drain valve	Ölablassventil	3/8" NPT
13	sensore massima temperatura olio	maximum oil temperature sensor	Maximale Öltemperatur-Sensor	
14	attacco per ECO / iniezione di liquido	connection for ECO / liquid injection	Economizer-Flüssigkeitseinspritzunganschluße	Ø 1" 1/8"
DV	rubinetto di compressione	discharge valve	Druckventil	DN 80
NP	targhetta	name plate	Verdichtertypschild	
SL	attacco di aspirazione	suction connection	Sauganschluß	104,0 mm - 4" 1/8"

Dimensioni di ingombro
Dimensional drawing
Maßzeichnungen

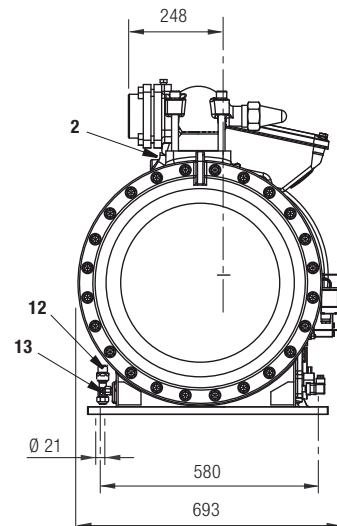
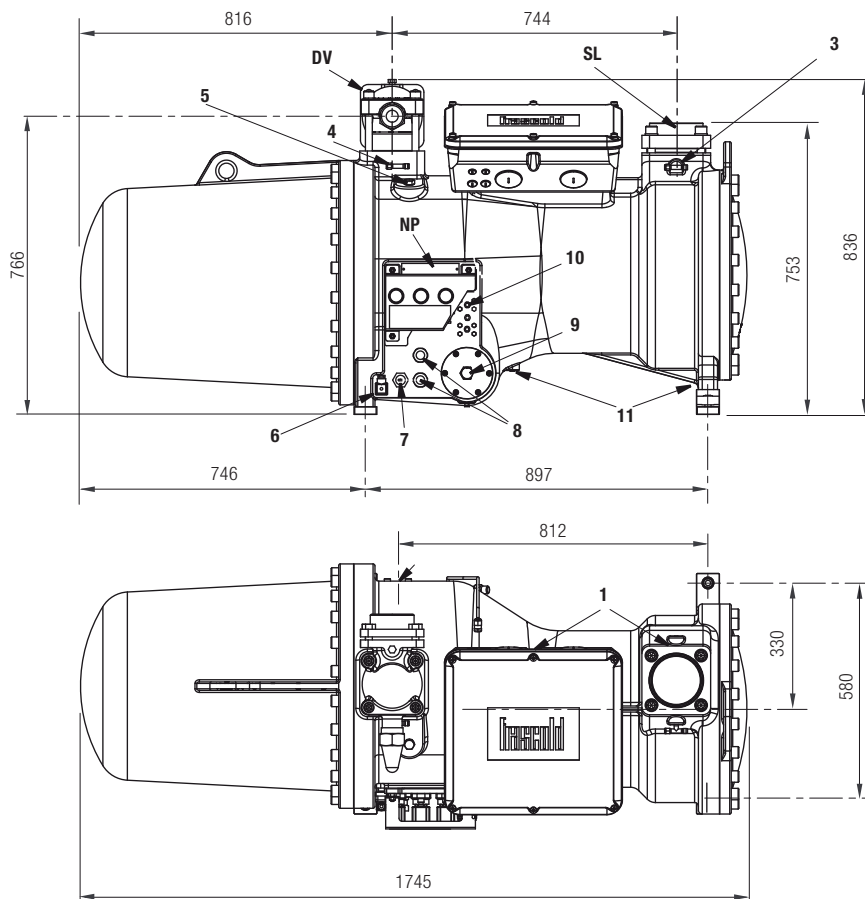

CXH92-180-545Y
CXH91-160-620Y
CXH92-240-702Y
CXH91-180-702Y

CXH91-210-810Y
CXH92-280-810Y
CXH91-240-912Y
CXH92-300-912Y

1	attacco di bassa pressione	low pressure connection	Saugseiteanschluß	1/8" NPT
2	attacco di alta pressione	high pressure connection	Druckseiteanschluß	1/8" NPT
3	attacco di bassa pressione	low pressure connection	Saugseiteanschluß	1/4" SAE x 1/4" SAE
4	attacco di alta pressione	high pressure connection	Druckseiteanschluß	1/4" SAE x 1/4" SAE
5	tappo carico olio	oil charge plug	Stopfen Ölfüllung	3/8" GAS
6	resistenza riscaldamento olio	crankcase heater	Ölsumpfheizung	
7	attacco per controllo livello olio	oil level monitoring connection	Ölniveau-überwachungsanschluß	M12 x 1.5
8	spia livello olio	oil level sight glass	Ölschauglas	
9	attacco per sensore intasamento filtro	connection for filter clogging sensor	Verstopfungszeigerfühleranschluß	1/2" GAS
10	attacchi per raffreddatore olio	connection for oil cooler	Ölkülerschluße	1/2" NPT
11	attacchi per scarico olio	connection for oil drain	Ölablass-Stopfen	1/4" NPT
12	valvola per scarico olio	oil drain valve	Ölablassventil	1/8" NPT
13	sensore massima temperatura olio	maximum oil temperature sensor	Maximale Öltemperatur-Sensor	
14	attacco per ECO / iniezione di liquido	connection for ECO / liquid injection	Economizer-Flüssigkeitseinspritzungsanschluße	Ø 1" 1/8"
NP	targhetta	name plate	Verdichtertypschild	
solo per:		only for:	nur für:	
CXH91-160-620Y	CXH92-180-545Y	CXH91-180-702Y	CXH92-210-620Y	CXH92-240-702Y
DV	rubinetto di compressione	discharge valve	Druckventil	DN 80
SL	attacco di aspirazione	suction connection	Sauganschluß	104,0 mm - 4" 1/8"
solo per:		only for:	nur für:	
CXH91-210-810	CXH91-240-912Y	CXH92-280-810Y	CXH92-300-912Y	
DV	rubinetto di compressione	discharge valve	Druckventil	104,0 mm - 4" 1/8"
SL	attacco di aspirazione	suction connection	Sauganschluß	DN 125

Da oltre 75 anni Frascold progetta, costruisce e vende compressori per l'industria della refrigerazione, condizionamento dell'aria e pompe di calore. La attuale gamma di compressori copre capacità frigorifere fino a 1400 kW e comprende compressori per applicazioni sia con i refrigeranti artificiali più tradizionali che per applicazioni con i refrigeranti naturali, CO₂, ammoniaca, idrocarburi. Ultimamente è stata lanciata una nuova linea di compressori specificatamente ottimizzata per i refrigeranti con basso valore GWP, compreso gli HFO. Tutti i compressori Frascold si distinguono sul mercato per la robustezza, affidabilità, prestazioni elevate, flessibilità di impiego.

For more than 75 years Frascold has been designing, manufacturing and selling compressors for the refrigeration, air conditioning and heat pump industries. The current range of compressors covers cooling capacities of up to 1400 kW, and includes compressors for applications with both more conventional artificial refrigerants as well as natural refrigerants such as CO₂, ammonia and hydrocarbons. Recently the company launched a new line of compressors specifically optimized for low GWP refrigerants, including HFOs. All Frascold compressors are distinguished on the market for their durability, reliability, high performance and flexibility in use.

Seit mehr als 75 Jahren entwickelt, baut und vertreibt Frascold Industrie-Kompressoren für den Einsatz in Kühlanlagen, Klimaanlage und Wärmepumpen. Die aktuelle Produktpalette an Kompressoren deckt eine Kühlleistung von bis zu 1400 kW ab und umfasst Kompressoren zur Anwendung in Kühlgeräten mit herkömmlichen künstlichen Kühlmitteln sowie in Geräten mit natürlichen Kühlmitteln, wie CO₂, Ammoniak und Kohlenwasserstoff. Vor kurzem wurde eine neue Linie an Kompressoren auf den Markt gebracht, die speziell für Kühlmittel mit geringem Treibhauspotenzial (GWP) optimiert wurde, unter anderem für das Kältemittel HFO. Alle Kompressoren von Frascold zeichnen sich durch Ihre Robustheit, Zuverlässigkeit, hohe Leistung und Anwendungsflexibilität aus.

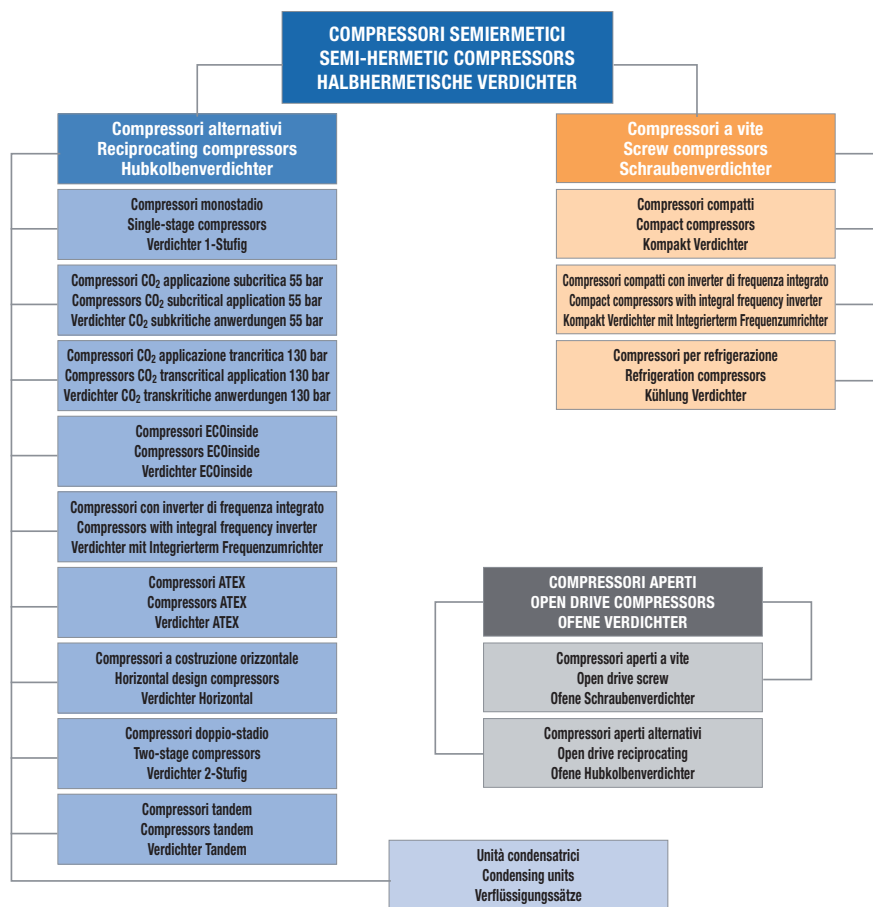

Informazioni Generali

Frascold si riserva la proprietà del contenuto del presente catalogo, nessuna riproduzione è concessa senza il nostro esplicito consenso.

I dati e le informazioni contenuti nel presente catalogo sono stati decisi in base alle nostre capacità e non dispensano l'utente dal suo dovere di controllare l'adeguatezza dei prodotti al riguardo della applicazione prefissata.

Frascold si riserva il diritto di modificare il contenuto del presente catalogo a fronte delle normali innovazioni e aggiornamenti ritenuti opportuni.

General Informations

Frascold reserves itself the ownership of the contents of the present catalogue; no reproduction is allowed without Frascold explicit consent.

The data and the information contained in the present catalogue have been decided based on our skills, and they do not exempt the user from his duty to control the adequacy of the products with regards to the specific application.

Frascold reserves itself the right to modify the content of the present catalogue, in view of normal innovations and updates deemed appropriate.

Allgemeine Informationen

Der Inhalt dieses Katalogs ist das Eigentum von Frascold, jede Art der Vervielfältigung ist ohne die ausdrückliche Genehmigung von Frascold untersagt. Die in diesem Katalog enthaltenen Angaben und Daten wurden anhand unseres Wissens festgelegt, dennoch sind der Kunde dazu verpflichtet, die Eignung der Produkte in Bezug auf ihre jeweilige Einsatzbestimmung zu prüfen. Frascold behält sich das Recht vor, angesichts normaler Neuerungen und erforderlicher Aktualisierungen Veränderungen am Inhalt dieses Katalogs vorzunehmen.

Blue is better

Headquarters:

FRASCOLD SpA

Via B.Melzi 105

20027 Rescaldina MI - Italy

tel. +39 0331 742201

fax +39 0331 576102

e-mail frascold@frascold.it

www.frascold.it

Indian branch:

FRASCOLD INDIA PRIVATE LIMITED

Corporate office

C - 908, Titanium Square,
Thaltel Cross Roads, S.G.Road,
Ahmedabad - 380054
Gujarat, India

tel. +91 79 40190411 - 4

fax +91 79 40190415

e-mail sales@frascoldindia.com

www.frascoldindia.com

Factory & Service centre

Survey no. – 509/2, Changodar-Bavla
Road, NH 8A

Opp Cadila pharma SEZ, Matoda,
Ahmedabad, 382213
Gujarat, India

Tel: +91 9428607443

e-mail sales@frascoldindia.com

www.frascoldindia.com

Mumbai Sales Office

Level-13,Platinum Technopark 17&18
Sector-30A,Vashi,
Mumbai-400 703,
Maharashtra, India.

tel. +91-22-61214936

fax +91-22-61214950

e-mail swamy@frascoldindia.com

www.frascoldindia.com